

Section G

CABLES

NOTE: *The cables listed in this section are arranged in primary part number sequence. At the bottom of each page, the primary part number appears first followed by a 57-860 or 57-861 (package) part number in some cases. Internal cabling may not have a 57-860 or 57-861 part number assigned. **When ordering a cable assembly, use the 57-860 or 57-861 part number whenever listed on the applicable page!***

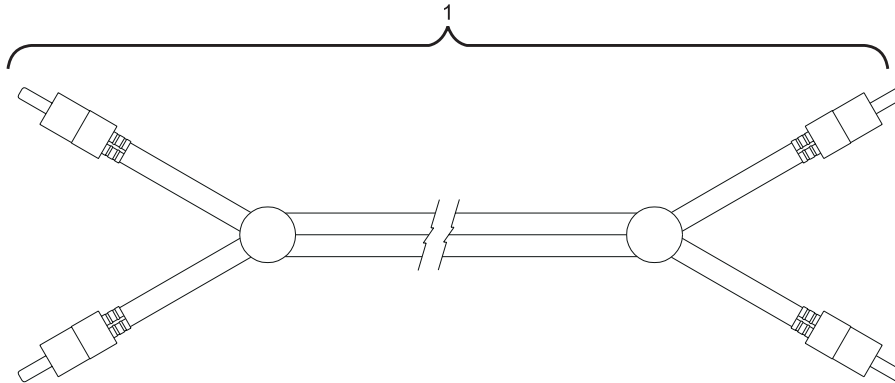

Index No.	Part No.	Description
1.	11-681310-000	CMS Audio/Video Control Box RCA to RCA Cable Assembly

**CMS Audio Video Control Box RCA to RCA Cable Assembly
11-681310-000**

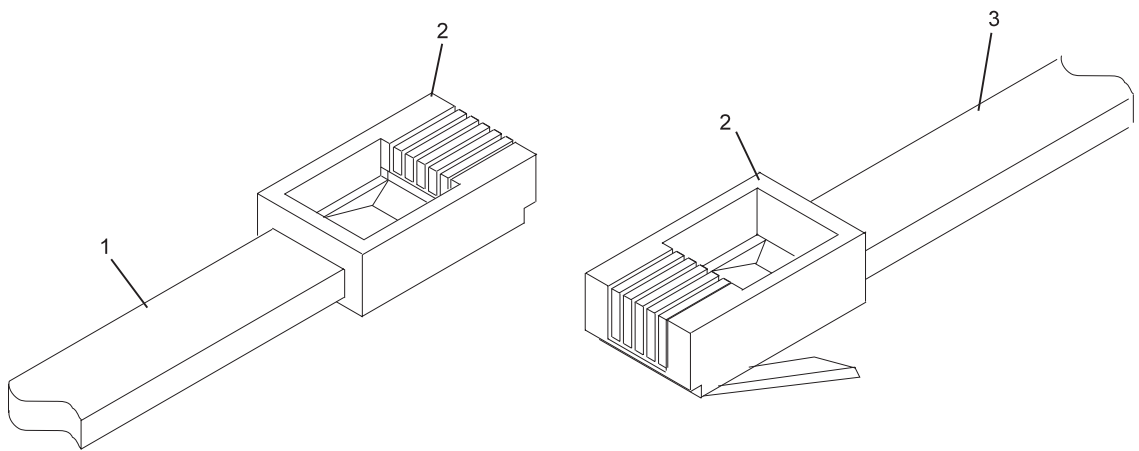

Index No.	Part No.	Description
1.	N.A.	Communications Cable Assembly
2.	11-680177-002	6 Position Modular Line-Cord Connector
3.	27-619040-000	Bulk Wire, 6 Conductor Phone Cable

N.A. = Not Available as an assembly

**6 Conductor Phone Cable Assembly
27-619040-000**

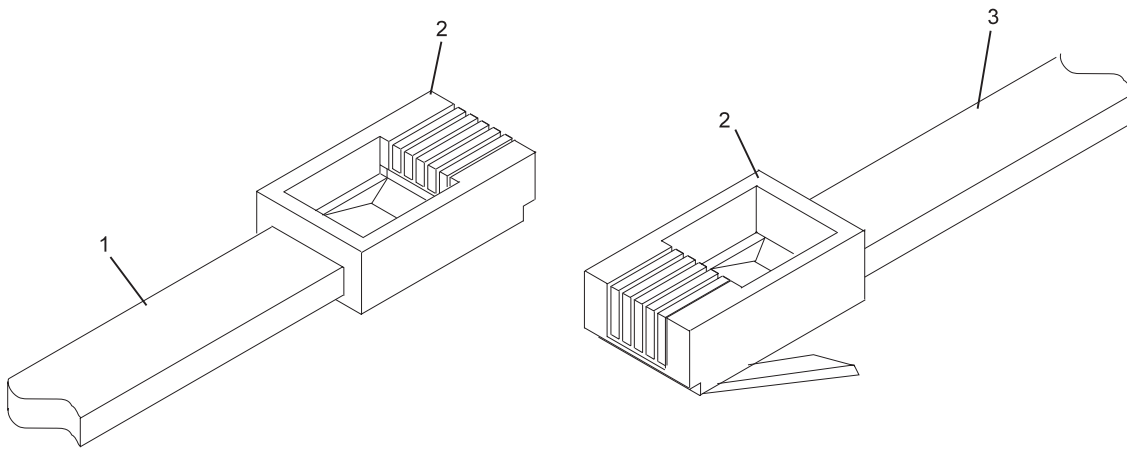

Index

No.	Part No.	Description
1.	N.A.	Communications Cable Assembly
2.	11-680177-003	4 Position Modular Line-Cord Connector
3.	27-619042-000	Bulk Wire, 4 Conductor Phone Cable

N.A. = Not Available as an assembly

**4 Conductor Phone Cable Assembly
27-619042-000**

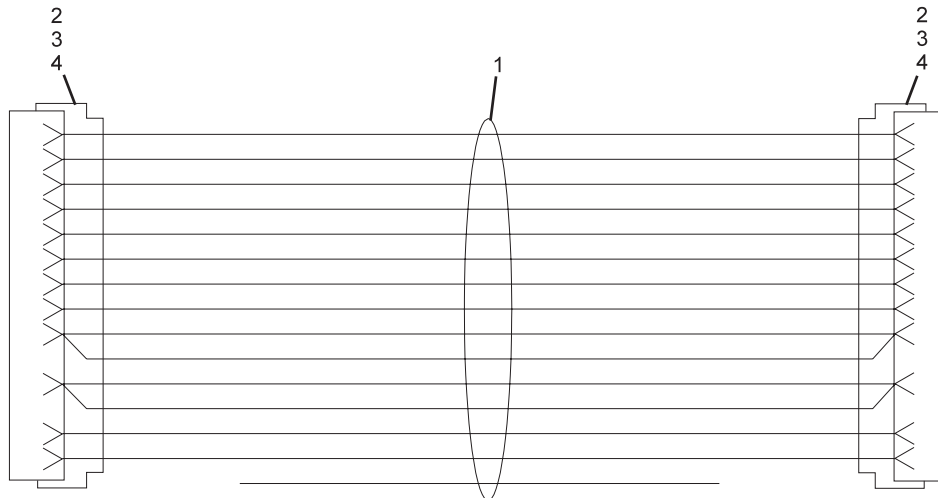

Index

No.	Part No.	Description
1.	57-215171-000	Test Set to Camera Bracket Cable Assembly
2.	11-692091-000	Connector
3.	11-692312-000	Connector
4.	11-692080-000	Strain Relief

**Test Set to Camera Bracket Cable Assembly
57-215171-000**

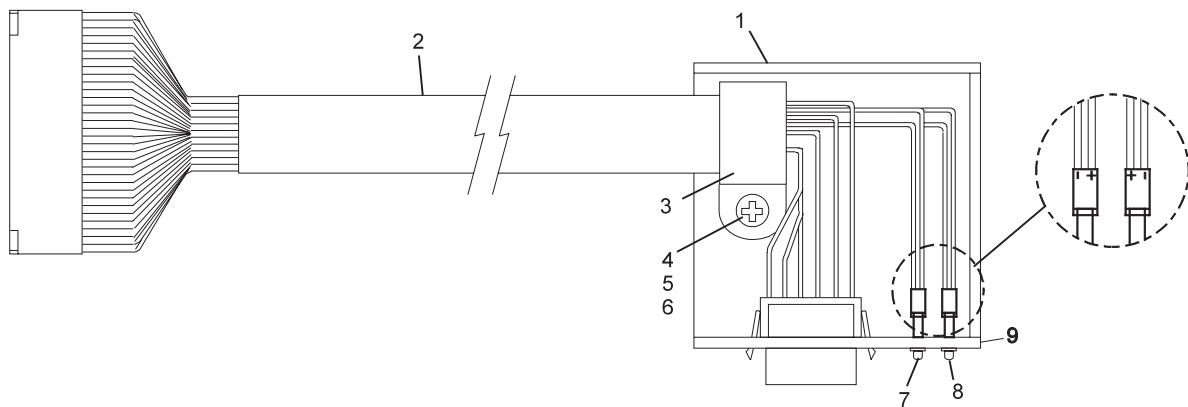

Index No.	Part No.	Description
1.	57-215172-000	LED Camera Cable Assembly
2.	57-215210-000	LED Cable Assembly
3.	11-604104-000	Cable Clamp
4.	11-012308-001	Pan Hd. C.R. Screw (#8-32 x 3/8")
5.	11-195008-001	Lock Washer (#8)
6.	11-125003-001	Hex Nut
7.	11-680806-000	LED
8.	11-680807-000	LED
9.	57-215183-000	Cable Assembly Bracket

**CCD Processor to Test Set Bracket Cable Assembly
57-215172-000**

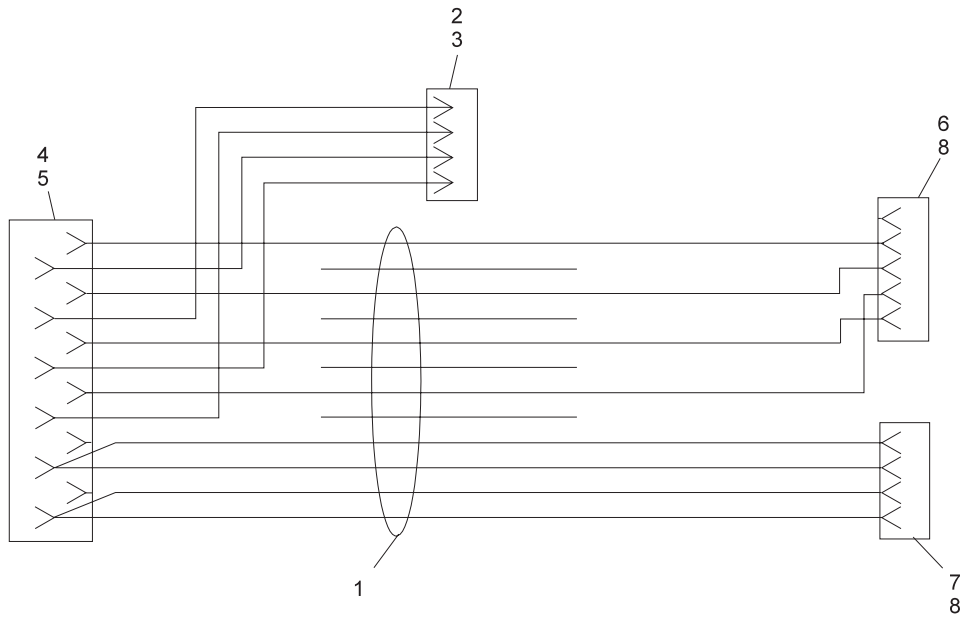

Index

No.	Part No.	Description
1.	57-860398-000	Pinsetter Interface to CCD Processor Cable Assembly
2.	11-692204-000	Connector
3.	11-692090-000	Terminal
4.	11-696801-000	Connector
5.	11-696927-000	Terminal
6.	11-697216-000	Connector
7.	11-697238-000	Connector
8.	11-680326-000	Terminal

**Pinsetter Interface to CCD Processor Cable Assembly
57-215229-000 (57-860398-000)**

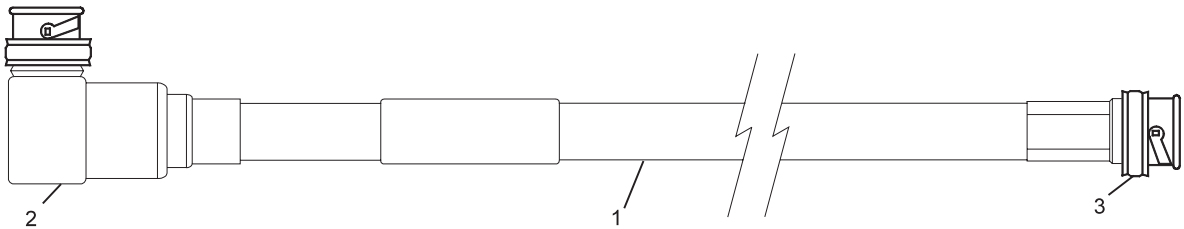

Index No.	Part No.	Description
1.	57-215377-000	Camera to CCD Processor (Clock or Video) Cable Assembly
2.	11-690249-000	BNC Connector
3.	11-696265-000	BNC Connector

**Camera to CCD Processor
(Clock or Video) Cable Assembly
57-215377-000**

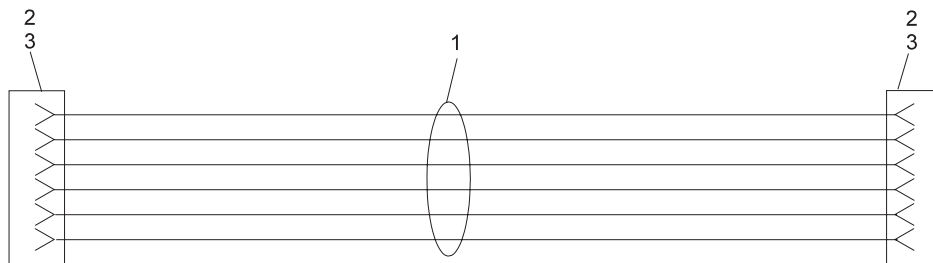

Index No.	Part No.	Description
1.	57-215379-000	Camera to CCD Processor Cable Assembly
2.	11-692306-000	Connector
3.	11-692091-000	Terminal

**Camera to CCD Processor Cable Assembly
57-215379-000**

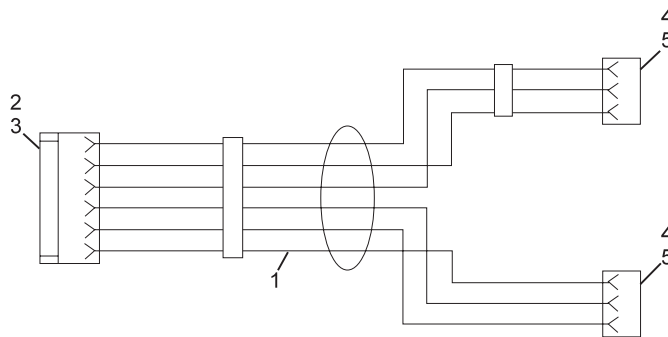

Index

No.	Part No.	Description
1.	57-215391-000	Ball Detect to CCD Processor Cable Assembly
2.	11-697239-000	Connector
3.	11-680326-000	Terminal
4.	11-680201-000	Connector
5.	11-680301-000	Terminal

**Ball Detect to CCD Processor Cable Assembly
57-215391-000**

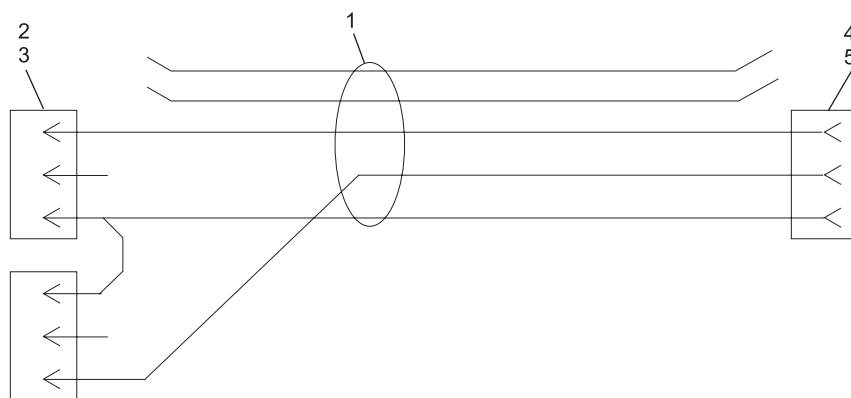

Index

No.	Part No.	Description
1.	57-215395-000	Foul Pick Up (Surface Return) Cable Assembly
2.	11-680201-000	Connector
3.	11-680301-000	Terminal
4.	11-697239-000	Connector
5.	11-680326-000	Terminal

**Foul Pick Up (Surface Return) Cable Assembly
57-215395-000 (57-861245-000)**

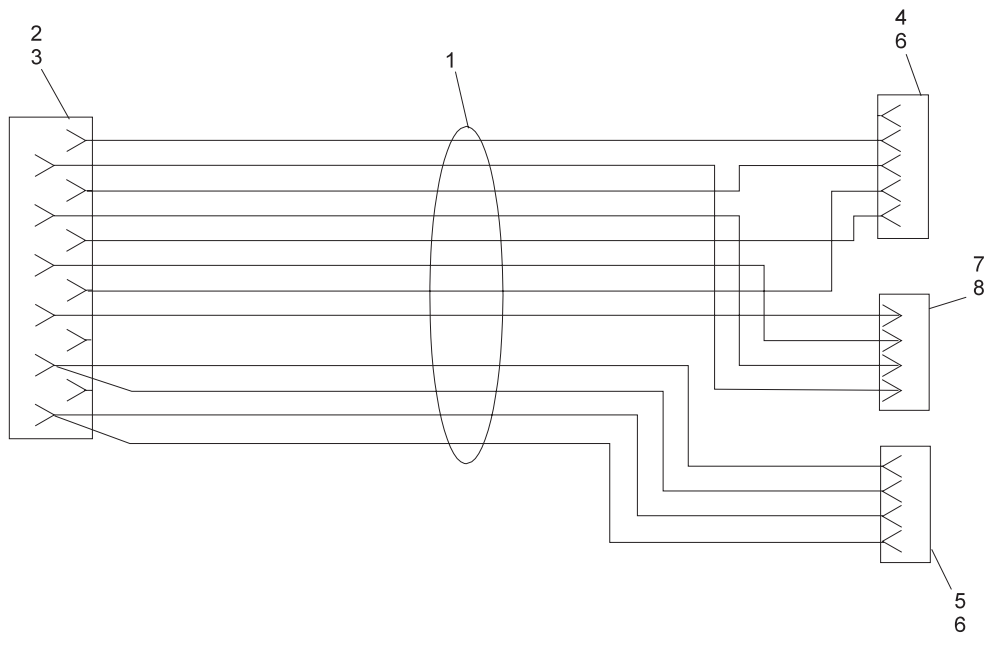

Index No.	Part No.	Description
1.	57-215396-000	Pinsetter Interface to CCD Processor Cable Assembly
2.	11-696801-000	Connector
3.	11-696927-000	Terminal
4.	11-697216-000	Connector
5.	11-697238-000	Connector
6.	11-680326-000	Terminal
7.	11-680105-000	Connector
8.	11-680302-000	Terminal

**Pinsetter Interface to CCD Processor Cable Assembly
57-215396-000**

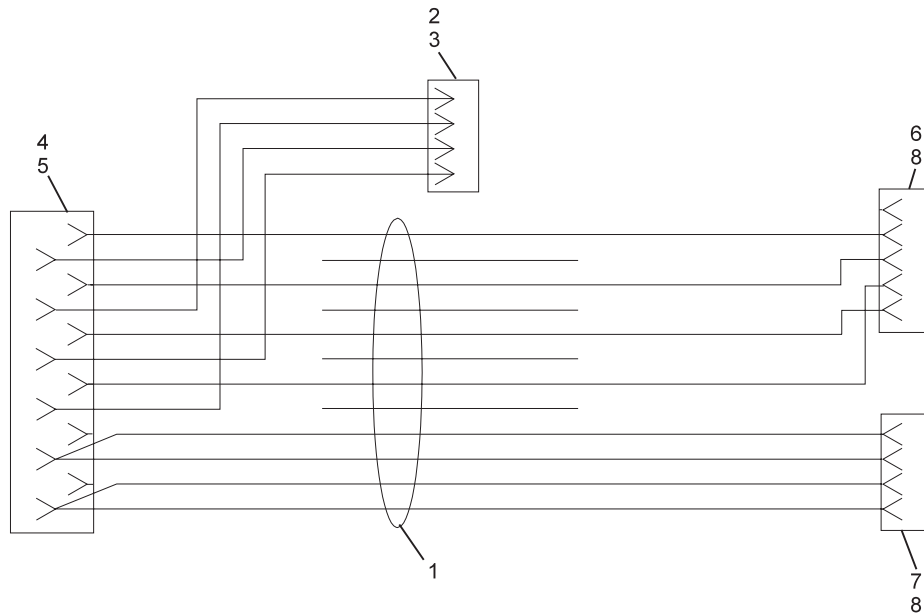

Index		
No.	Part No.	Description
1.	57-860512-000	Pinsetter Interface to CCD Processor Cable Assembly
2.	11-692204-000	Connector
3.	11-692090-000	Terminal
4.	11-696801-000	Connector
5.	11-696927-000	Terminal
6.	11-697216-000	Connector
7.	11-697238-000	Connector
8.	11-680326-000	Terminal

**Pinsetter Interface to CCD Processor Cable Assembly
57-215421-000 (57-860512-000)**

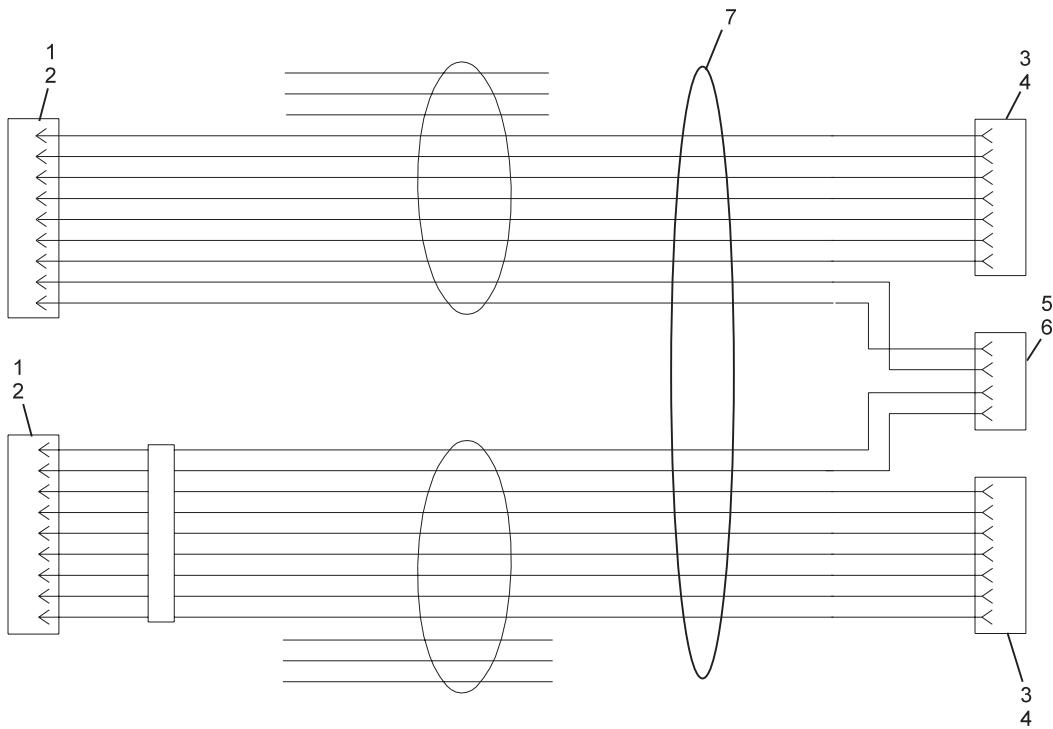

Index

No.	Part No.	Description
1.	57-215507-000	CCD Processor to AMF Interface Cable Assembly
2.	11-680108-000	Connector
3.	11-680302-000	Terminal
4.	11-697611-000	Connector
5.	11-680326-000	Terminal
6.	11-680205-000	Connector
7.	11-680301-000	Terminal

**CCD Processor to AMF Interface Cable Assembly
57-215507-000**

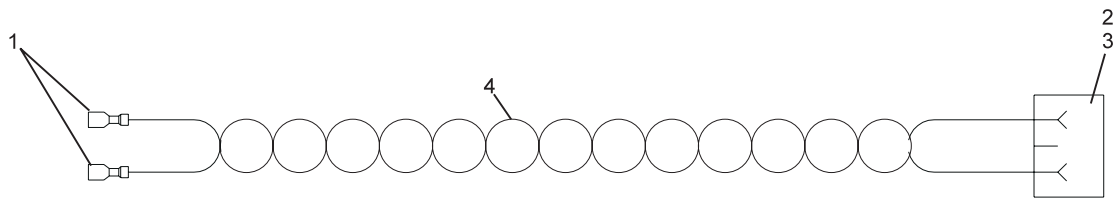

Index			
No.	Part No.	Description	
1.	11-612151-000	Terminal	
2.	11-691303-000	Connector	
3.	11-691298-000	Terminal	
4.	57-215809-000	Relay to Monitor Power Cable Assembly (Overhead Monitor)	

**Relay to Monitor Power Cable Assembly
57-215809-000**

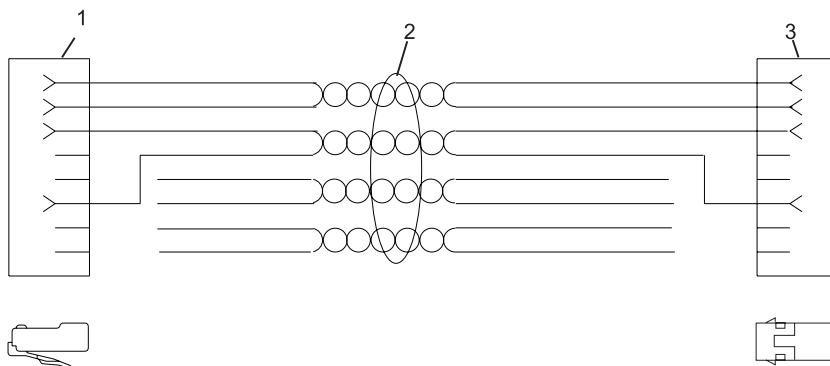

Index

No.	Part No.	Description
1.	57-861244-000	Connector RJ 45 Plug
2.	57-861208-000	Primary Console Ethernet to RJ 45 Junction Cable Assembly
3.	57-861209-000	Junction Connector

NOTE: When ordering package 57-861208-000, an inline junction connector, part number 57-861209-000, is included.

**Primary Console Ethernet to RJ45 Junction Cable Assembly
57-300003-000 (57-861208-000)**

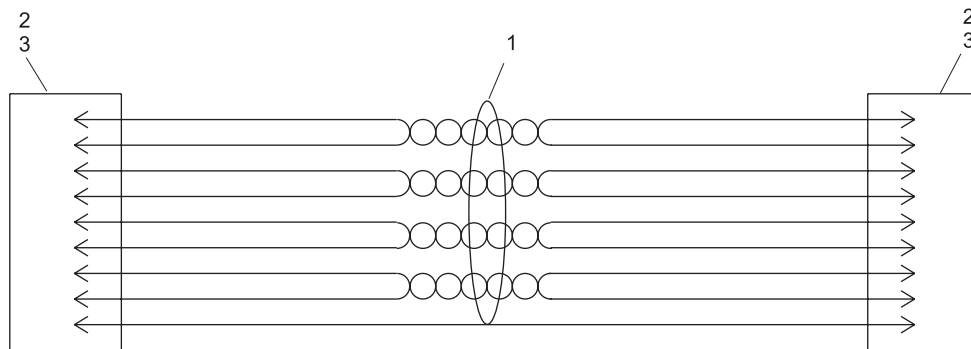

Index

No.	Part No.	Description
1.	57-300004-000	Primary Console Global Video from Front Desk
2.	11-680326-000	Terminal
3.	11-697217-000	Connector

**Primary Console Global Video from Front Desk (Field Assembled)
57-300004-000**

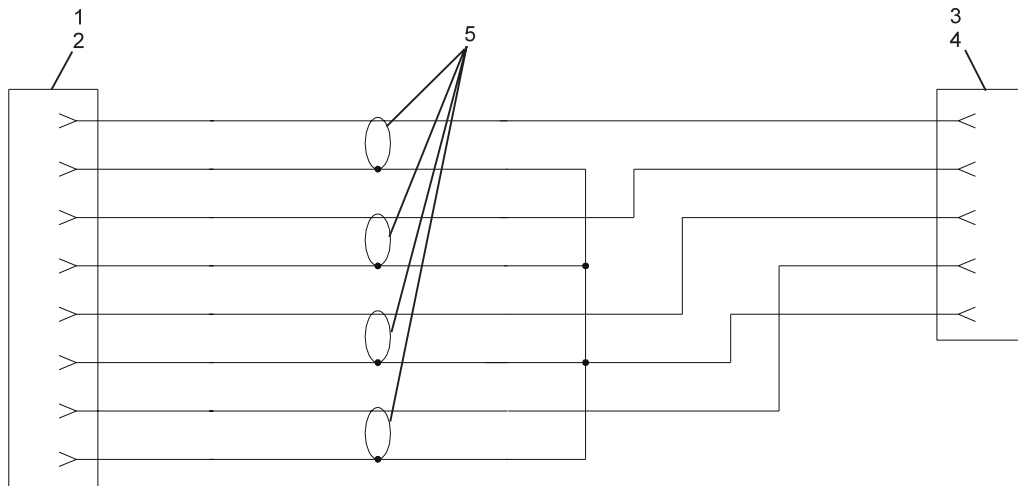

Index			
No.	Part No.	Description	
1.	11-696826-000	Connector	
2.	11-680330-000	Terminal	
3.	11-680217-000	Connector	
4.	11-680301-000	Terminal	
5.	57-861205-000	Primary Console Video to Secondary Console Video Cable Assembly	

**Primary Console Video to Secondary Console Video Cable Assembly
57-300005-000 (57-861205-000)**

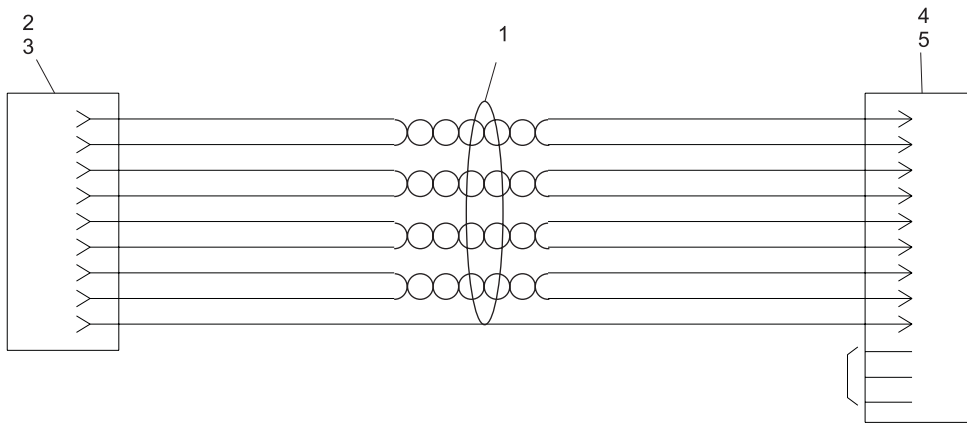

Index

No.	Part No.	Description
1.	57-300006-000	Front Desk to TV - Only Video Cable (Field Assembly)
2.	11-680322-000	Terminal
3.	11-697217-000	Connector
4.	11-680108-000	Connector
5.	11-680302-000	Terminal

**Front Desk to TV - Only Video Cable (Field Assembly)
57-300006-000**

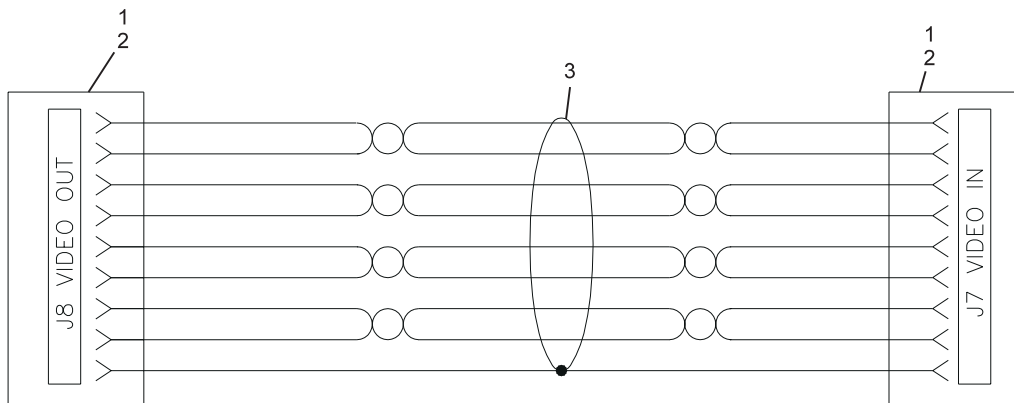

Index

No.	Part No.	Description
1.	11-697217-000	Connector
2.	11-680326-000	Terminal
3.	57-861202-000	Global Video LGP to LGP Cable Assembly

**Global Video LGP to LGP Cable Assembly
57-300007-000 (57-861202-000)**

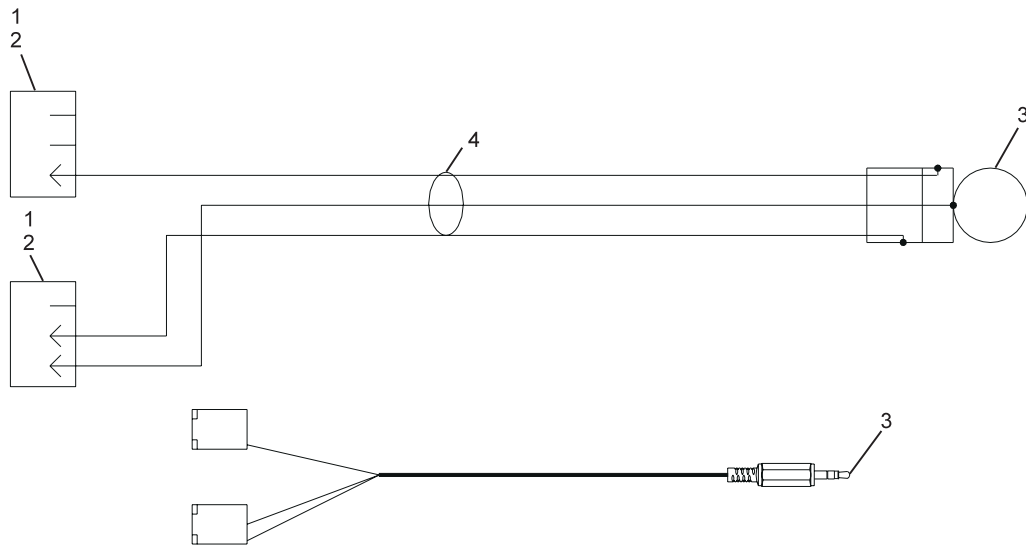

Index		
No.	Part No.	Description
1.	11-697237-000	Connector
2.	11-680326-000	Terminal
3.	11-681032-000	Connector (3.5 mm Stereo)
4.	57-860978-000	Sound Card Cable Assembly

Sound Card Cable Assembly
57-300008-000 (57-860978-000)

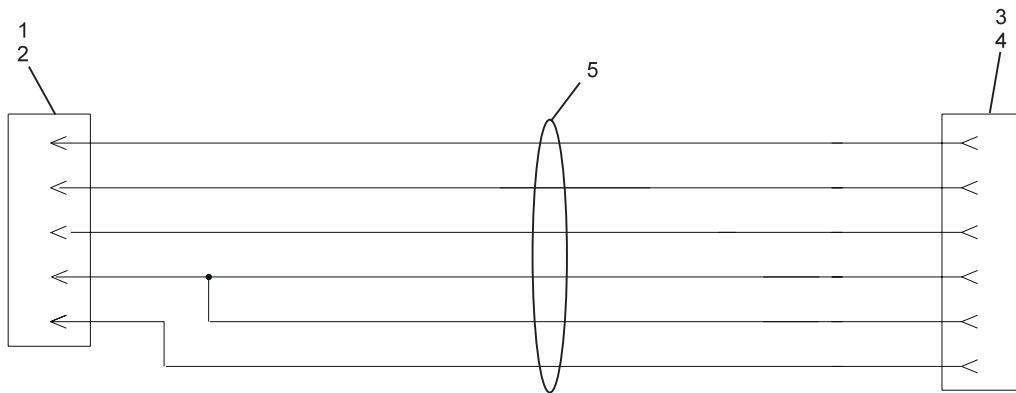

Index No.	Part No.	Description
1.	11-680117-000	Connector
2.	11-680302-000	Terminal
3.	11-691306-000	Connector
4.	11-691298-000	Terminal
5.	57-300009-000	Secondary Console Video Adapter Cable Assembly

**Secondary Console Video Adapter Cable Assembly
57-300009-000**

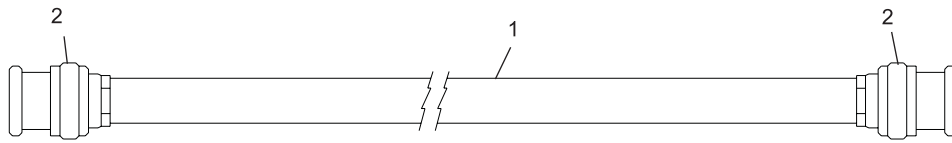

Index

No.	Part No.	Description
1.	57-300011-000	Front Desk to CMS to Hub LAN Cable (Field Assembly)
2.	11-696272-000	BNC Connector

**Front Desk to CMS to Hub LAN Cable Assembly (Field Assembly)
57-300011-000**

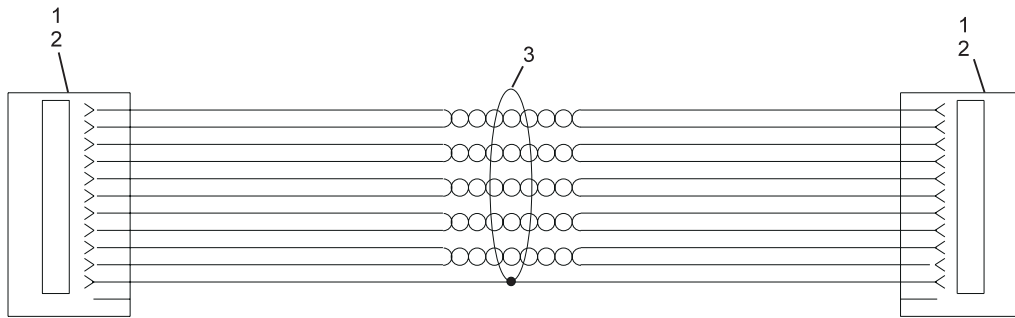

Index		
No.	Part No.	Description
1.	11-697242-000	Connector
2.	11-680326-000	Terminal
3.	57-861210-000	Global Audio Lane Pair to Lane Pair Cable Assembly

**Global Audio Lane Pair to Lane Pair Cable Assembly
57-300012-000 (57-861210-000)**

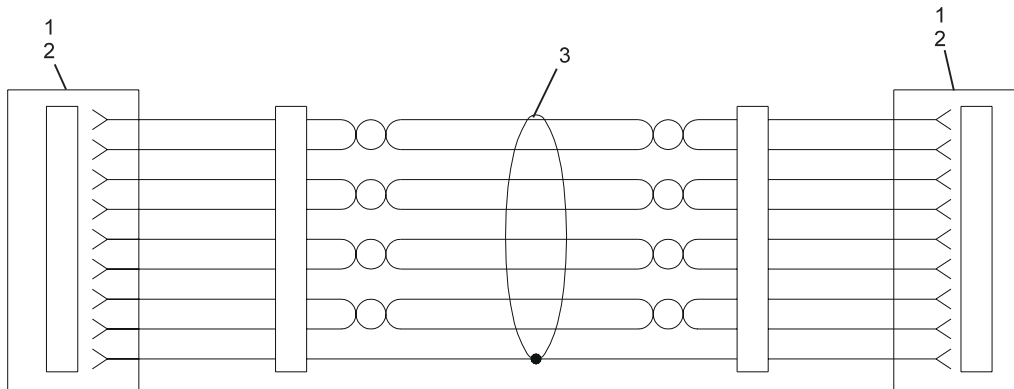

Index

No.	Part No.	Description
1.	11-697217-000	Connector
2.	11-680326-000	Terminal
3.	57-861203-000	Global Video Lane Pair to Lane Pair Cable Assembly

**Global Video Lane Pair to Lane Pair Cable Assembly
57-300013-000 (57-861203-000)**

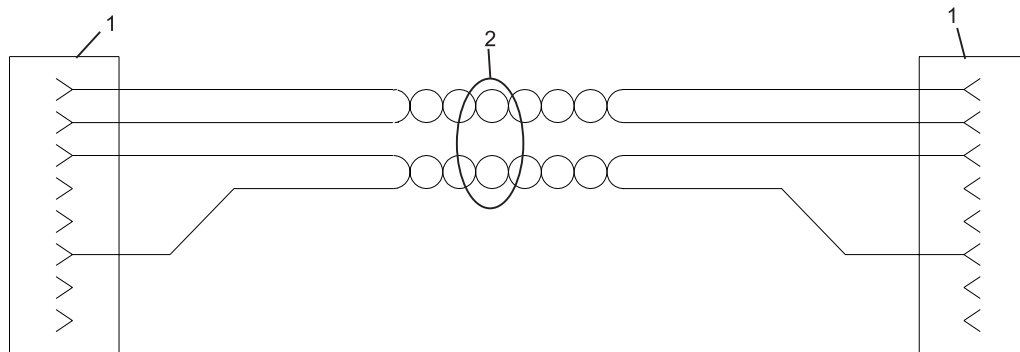

Index No.	Part No.	Description
1.	57-861244-000	Connector RJ45
2.	57-300014-000	Hub to RJ 45 Junction Cable Assembly (10')
	57-300015-000	Hub to RJ 45 Junction Cable Assembly (21')
	57-300016-000	Hub to RJ 45 Junction Cable Assembly (32')
	57-300017-000	Hub to RJ 45 Junction Cable Assembly (43')
	57-300018-000	Hub to RJ 45 Junction Cable Assembly (54')
	57-300019-000	Hub to RJ 45 Junction Cable Assembly (65')
	57-300020-000	Hub to RJ 45 Junction Cable Assembly (76')
	57-300021-000	Hub to RJ 45 Junction Cable Assembly (87')

NOTE: To order complete set, use part no. 57-861071-000.

**Hub to RJ 45 Junction Cable Assembly
57-300014-000 thru 57-300021-000**

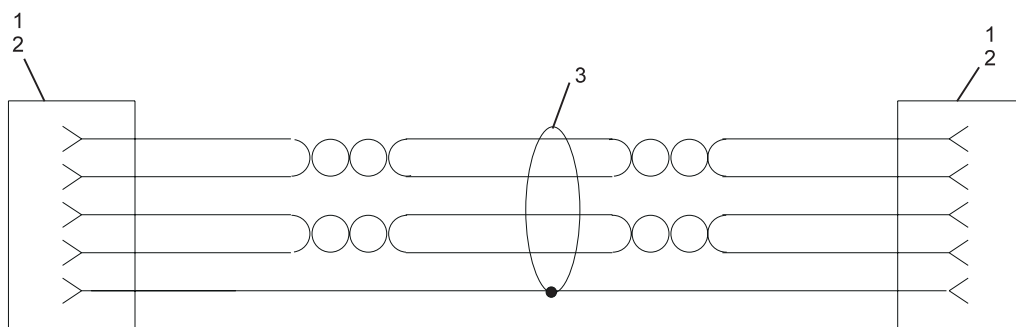

Index

No.	Part No.	Description
1.	11-697216-000	Connector
2.	11-680326-000	Terminal
3.	57-861246-000	Primary Console to Pinsetter Interface Local LAN Cable Assembly

**Primary Console to Pinsetter Interface Local LAN Cable Assembly
57-300022-000 (57-861246-000)**

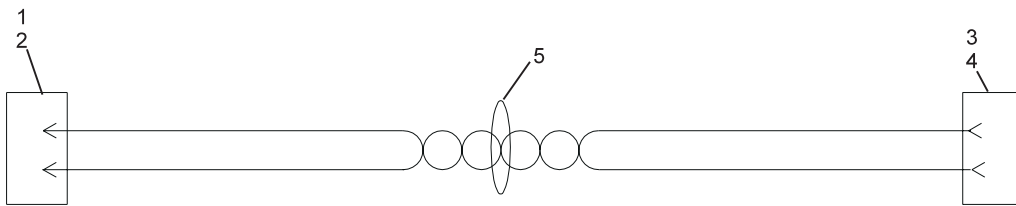

Index		
No.	Part No.	Description
1.	11-680116-000	Connector
2.	11-680302-000	Terminal
3.	11-697204-000	Connector
4.	11-680322-000	Terminal
5.	57-861247-000	Secondary Console to Pinsetter Interface 28VAC Cable Assembly

**Secondary Console to Pinsetter Interface 28VAC Cable Assembly
57-300023-000 (57-861247-000)**

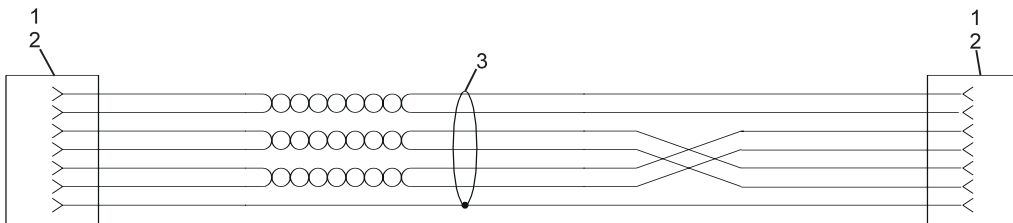

Index

No.	Part No.	Description
1.	11-697611-000	Connector
2.	11-680326-000	Terminal
3.	57-861206-000	Primary Console Local LAN to Secondary Console Local LAN Cable Assembly (40' Length)

NOTE : For 15' length order part number 57-861147-000.

**Primary Console Local LAN to Secondary Console Local LAN Cable Assembly
57-300025-000 (57-861206-000)**

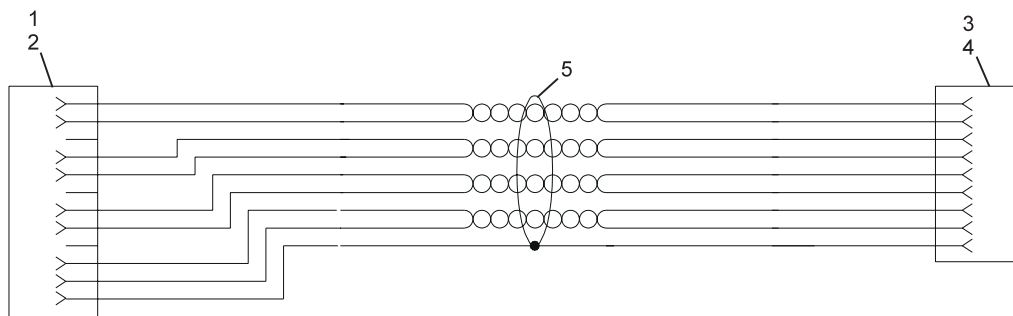

Index		
No.	Part No.	Description
1.	11-680108-000	Connector
2.	11-680302-000	Terminal
3.	11-691289-000	Connector
4.	11-691299-000	Terminal
5.	57-861200-000	Overhead Monitor Video Input from LGP Cable Assembly

**Overhead Monitor Video Input from LGP Cable Assembly
57-300026-000 (57-861200-000)**

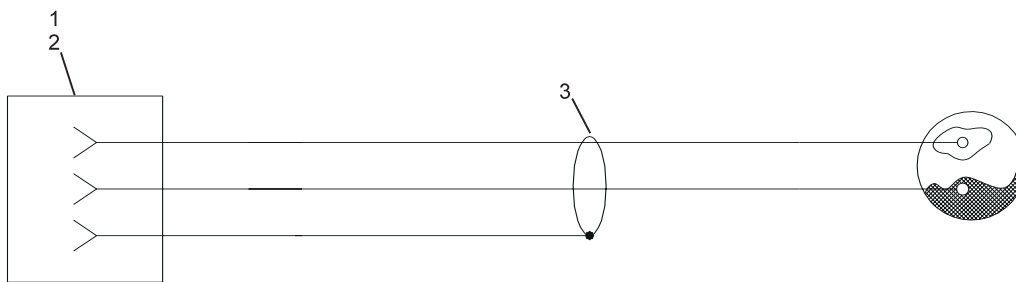

Index

No.	Part No.	Description
1.	11-697237-000	Connector
2.	11-680326-000	Terminal
3.	57-300028-000	Console Audio PCB to Microphone Cable Assembly

**Console Audio PCB to Microphone Cable Assembly
57-300028-000**

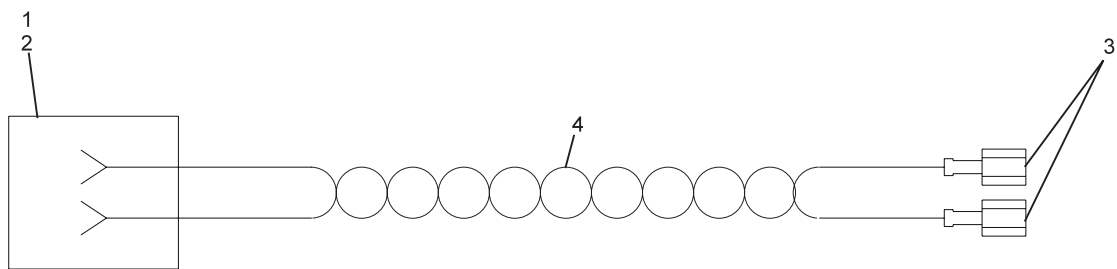

Index		
No.	Part No.	Description
1.	11-697204-000	Connector
2.	11-680325-000	Terminal
3.	11-612151-000	Terminal
4.	57-300030-000	Overhead Relay to Video Processor Power Control Cable Assembly

**Overhead Relay to Video Processor Power Control Cable Assembly
57-300030-000**

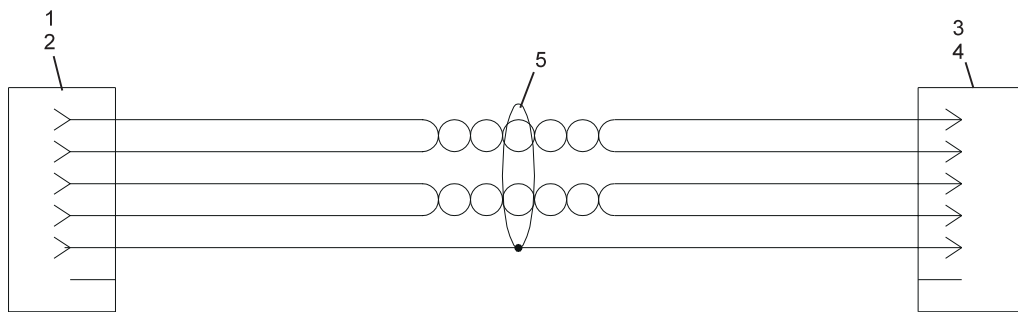

Index

No.	Part No.	Description
1.	11-697216-000	Connector
2.	11-680326-000	Terminal
3.	11-680107-000	Connector
4.	11-680302-000	Terminal
5.	57-861166-000	Pinsetter Interface to TV-Only Overhead Local LAN Cable Assembly

**Pinsetter Interface to TV-Only Overhead Local LAN Cable Assembly
57-300031-000 (57-861166-000)**

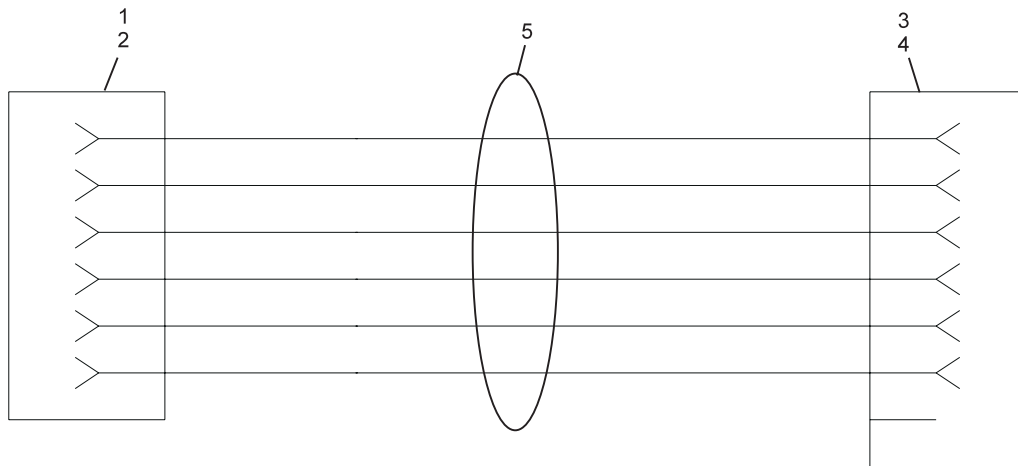

Index No.	Part No.	Description
1.	11-697239-000	Connector
2.	11-680326-000	Terminal
3.	11-691307-000	Connection
4.	11-691298-000	Terminal
5.	57-300032-000	Overhead Video Cable Assembly

**Overhead Video Cable Assembly
57-300032-000**

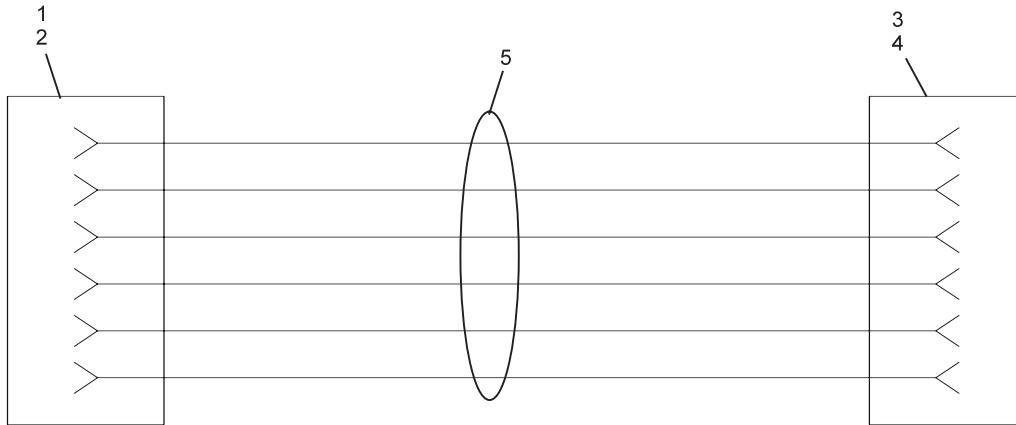

Index

No.	Part No.	Description
1.	11-697239-000	Connector
2.	11-680326-000	Terminal
3.	11-691306-000	Connector
4.	11-691298-000	Terminal
5.	57-300033-000	Console Video Board to Primary Console Monitor Cable Assembly

**Console Video Board to Primary Console Monitor Cable Assembly
57-300033-000**

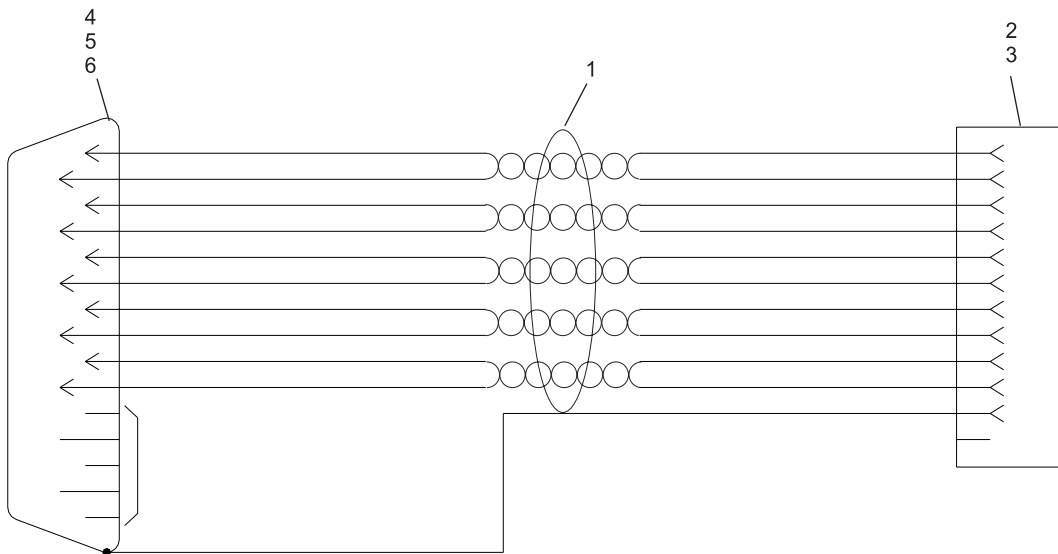

Index

No.	Part No.	Description
1.	57-300034-000	Front Desk To Primary Console Global Audio Cable (Field Assembly)
2.	11-680326-000	Terminal
3.	11-697242-000	Connector
4.	11-680998-000	Connector
5.	11-680999-000	Cover
6.	11-680981-000	Terminal

**Front Desk To Primary Console Global Audio Cable (Field Assembly)
57-300034-000**

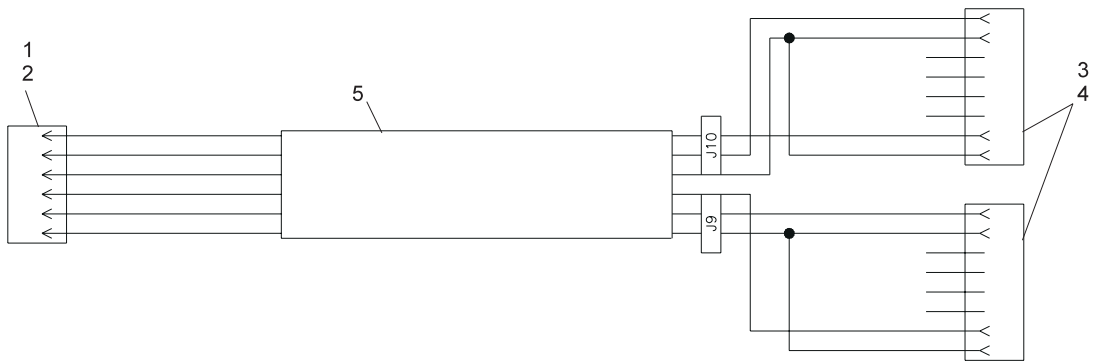

Index		
No.	Part No.	Description
1.	11-680107-000	Connector
2.	11-680302-000	Terminal
3.	11-697208-000	Connector
4.	11-680322-000	Terminal
5.	57-300036-000	A-2 Power & Cycle "Y" Cable Assembly

**A-2 Power & Cycle "Y" Cable Assembly
57-300036-000**

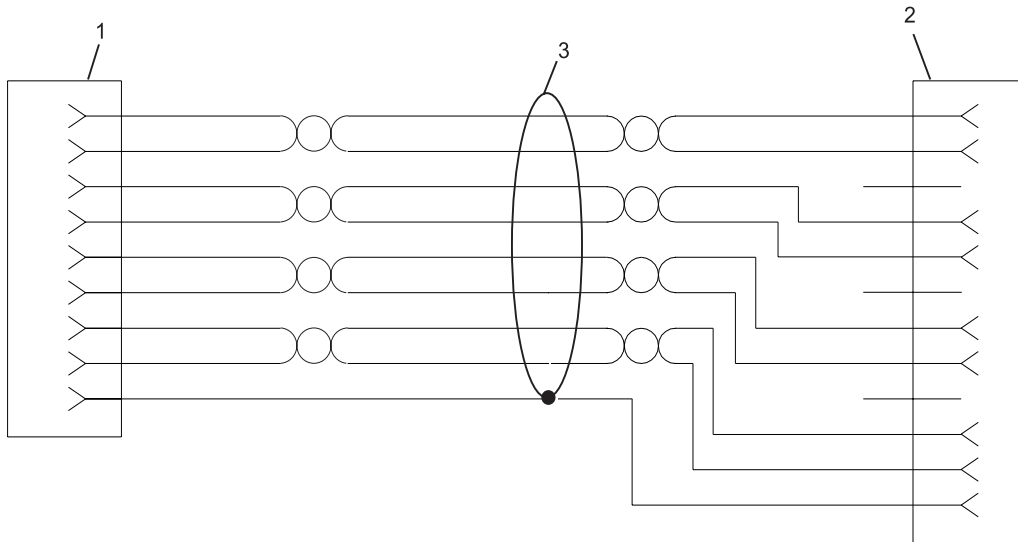

Index

No.	Part No.	Description
1.	11-697344-000	Connector
2.	11-697343-000	Connector
3.	57-300038-000	Bowler Entry Station Keyboard Extension Cable Assembly

**Bowler Entry Station Keyboard Extension Cable Assembly
57-300038-000**

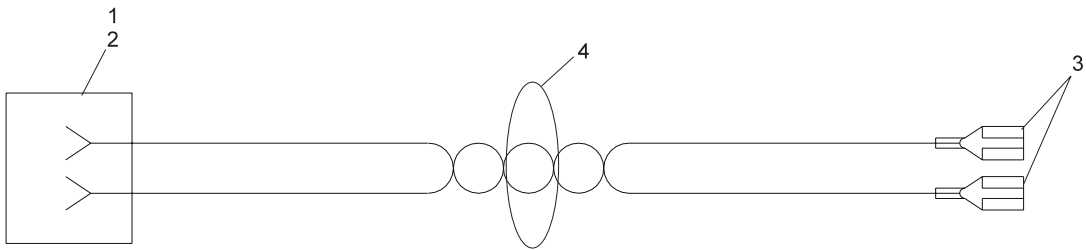

Index No.	Part No.	Description
1.	11-697204-000	Connector
2.	11-680322-000	Terminal
3.	11-612151-000	Terminal
4.	57-300048-000	Console Controller to Relay Power Control Cable Assembly

**Console Controller to Relay Power Control Cable Assembly
57-300048-000**

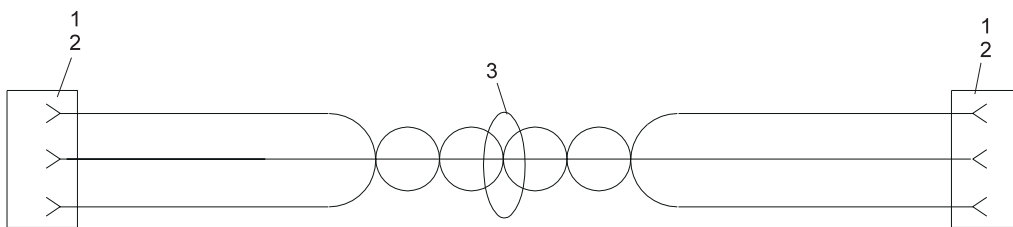

Index

No.	Part No.	Description
1.	11-697201-000	Connector
2.	11-680322-000	Terminal
3.	57-861207-000	Primary Console 18 VAC to Secondary Console Cable Assembly

**Primary Console 18 VAC to Secondary Console Cable Assembly
57-300051-000 (57-861207-000)**

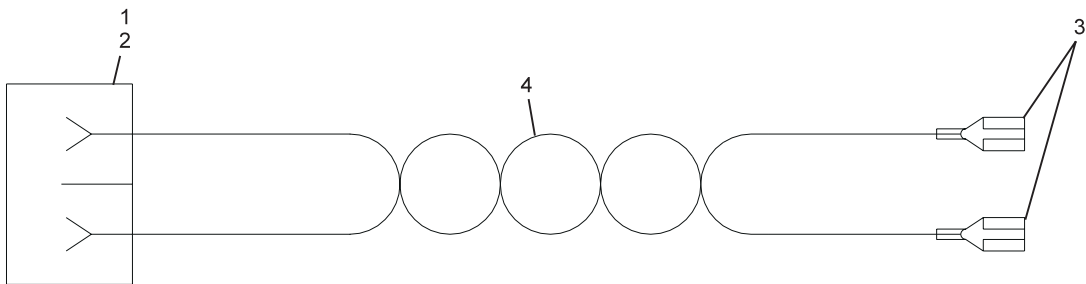

Index

No.	Part No.	Description
1.	11-691303-000	Connector
2.	11-691298-000	Terminal
3.	11-612151-000	Terminal
4.	57-300059-000	Power Control Relay to Console Monitor Cable Assembly (12")

**Power Control Relay to Console Monitor Cable Assembly
57-300059-000**

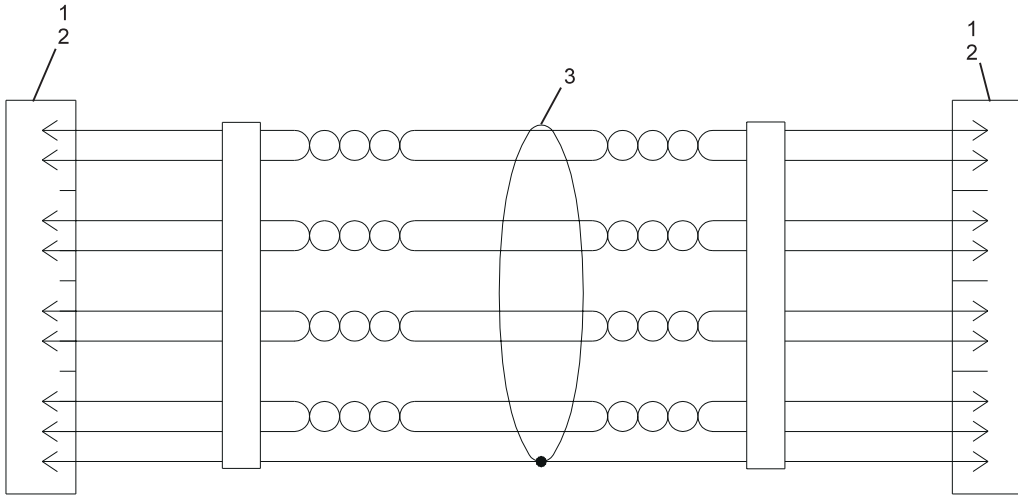

Index

No.	Part No.	Description
1.	11-680108-000	Connector
2.	11-680308-000	Terminal
3.	57-300061-000	Overhead TV-Only Lane Pair to Lane Pair Cable (Field Assembled)

**Overhead TV-Only Lane Pair to Lane Pair Cable (Field Assembled)
57-300061-000**

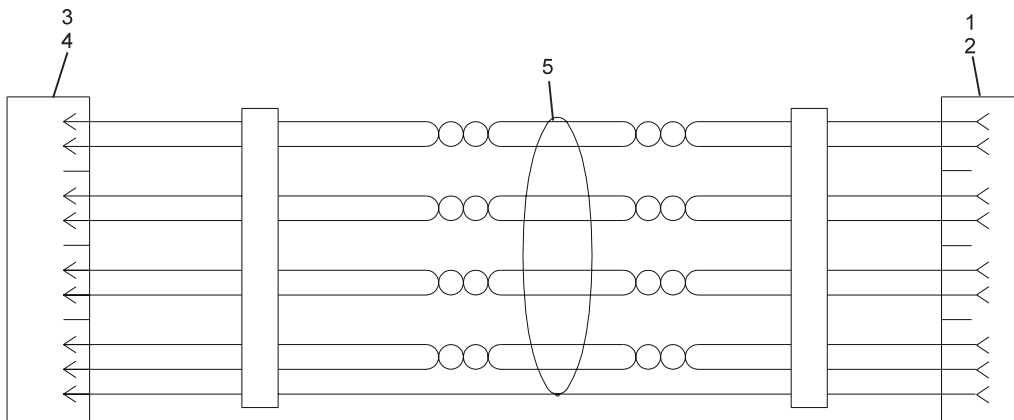

Index		
No.	Part No.	Description
1.	11-680301-000	Terminal
2.	11-680208-000	Connector
3.	11-680302-000	Terminal
4.	11-680108-000	Connector
5.	57-300062-000	Overhead Video Extension Cable Assembly

**Overhead Video Extension Cable Assembly
57-300062-000**

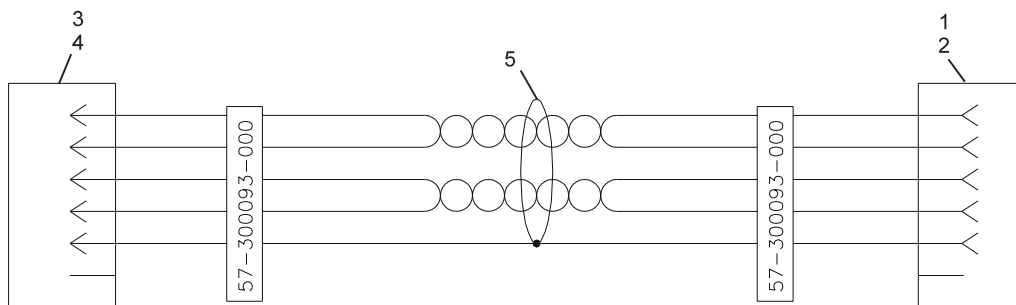

Index

No.	Part No.	Description
1.	11-680301-000	Terminal
2.	11-680207-000	Connector
3.	11-680302-000	Terminal
4.	11-680107-000	Connector
5.	57-300093-000	Overhead LAN Extension Cable Assembly

**Overhead LAN Extension Cable Assembly
57-300093-000**

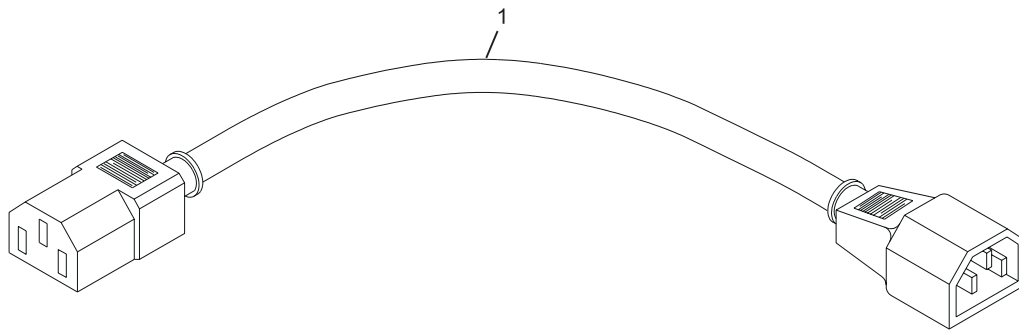

Index No.	Part No.	Description
1.	57-300095-000	Overhead Extension - Power Cord

**Overhead Extension Power Cord
57-300095-000**

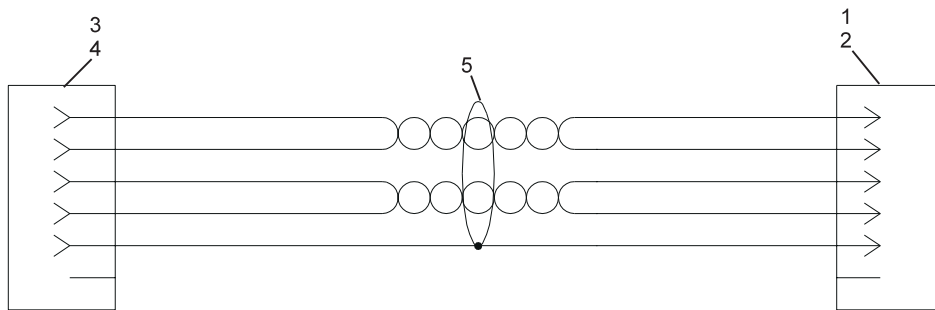

Index

No.	Part No.	Description
1.	11-680107-000	Connector
2.	11-680302-000	Terminal
3.	11-697239-000	Connector
4.	11-680326-000	Terminal
5.	57-861163-000	TV Only Overhead Local LAN Cable Assembly

**TV Only Overhead Local LAN Cable Assembly
57-300099-000 (57-861163-000)**

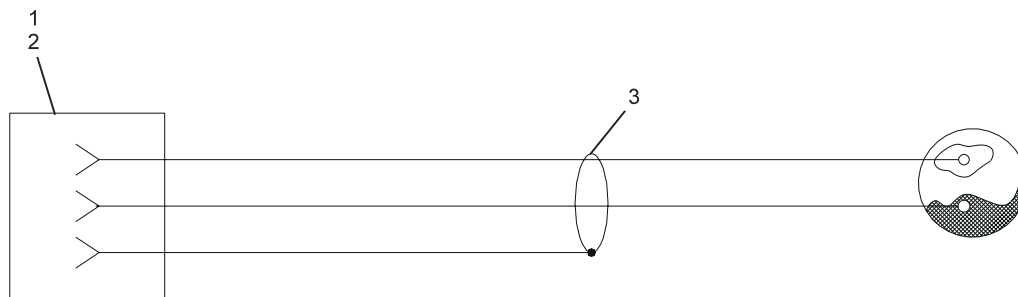

Index		
No.	Part No.	Description
1.	11-697237-000	Connector
2.	11-680326-000	Terminal
3.	57-300129-000	Bowler Entry Station Audio to Microphone Cable Assembly

**Bowler Entry Station Audio to Microphone Cable Assembly
57-300129-000**

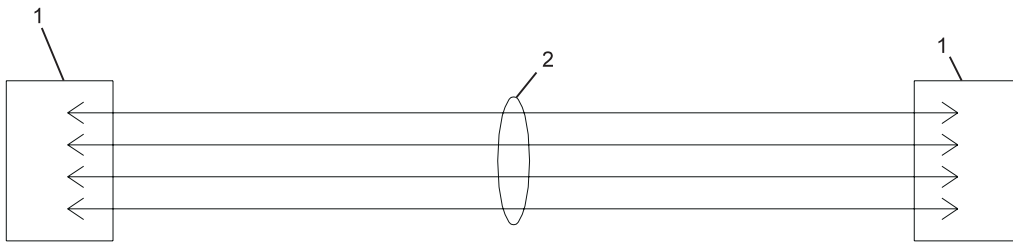

Index

No.	Part No.	Description
1.	11-680177-003	Connector
2.	57-861066-000	Intercom to Front Desk Audio/ Video Unit Cable Assembly (Field Assembled)

**Intercom to Front Desk Audio/Video Unit Cable Assembly
57-300132-000 (57-861066-000)**

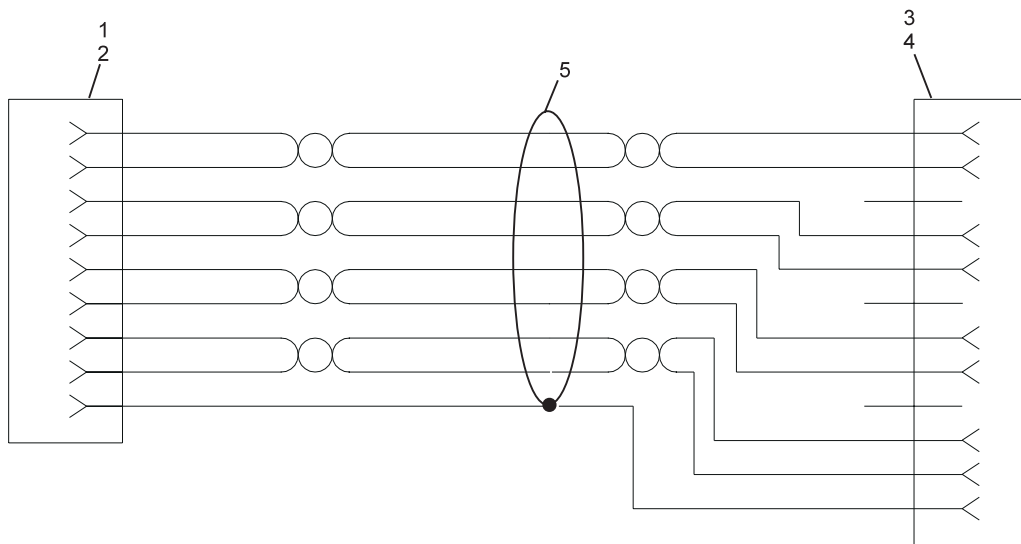

Index		
No.	Part No.	Description
1.	11-697217-000	Connector
2.	11-680326-000	Terminal
3.	11-680208-000	Connector
4.	11-680301-000	Terminal
5.	57-300138-000	Overhead AC Power Panel to Video Receiver PCB Cable Assembly

**Overhead AC Power Panel to Video Receiver PCB Cable Assembly
57-300138-000**

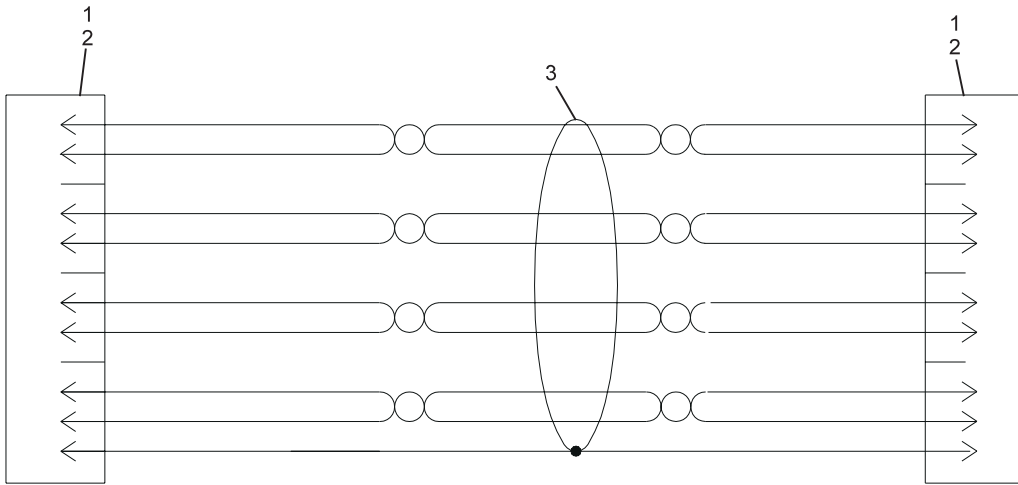

Index

No.	Part No.	Description
1.	11-680108-000	Connector
2.	11-680302-000	Terminal
3.	57-861165-000	Overhead TV-Only Lane Pair to Lane Pair Cable Assembly

**Overhead TV-Only Lane Pair to Lane Pair Cable Assembly
57-300139-000 (57-861165-000)**

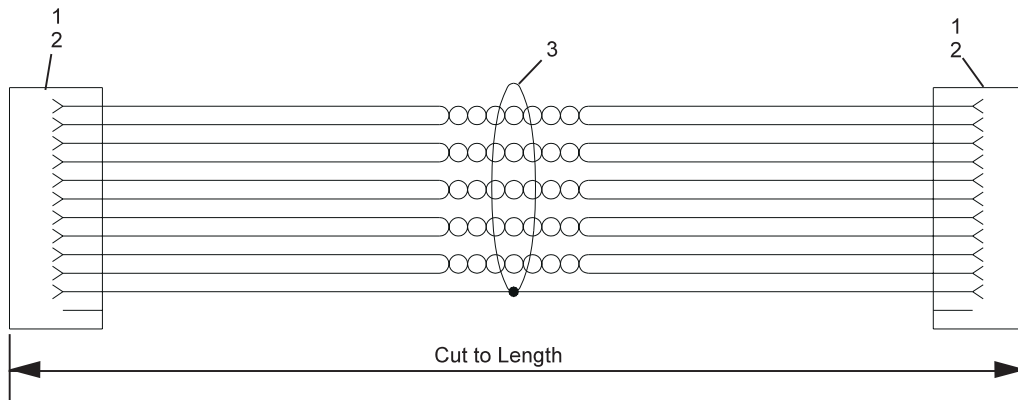

Index No.	Part No.	Description
1.	11-697242-000	Connector
2.	11-680323-000	Terminal
3.	*27-619504-000	Bulk Cable

* Not available as an assembly.

Global Audio Lane Pair to Lane Pair Cable Assembly
(Field Assembly)
57-300143-000

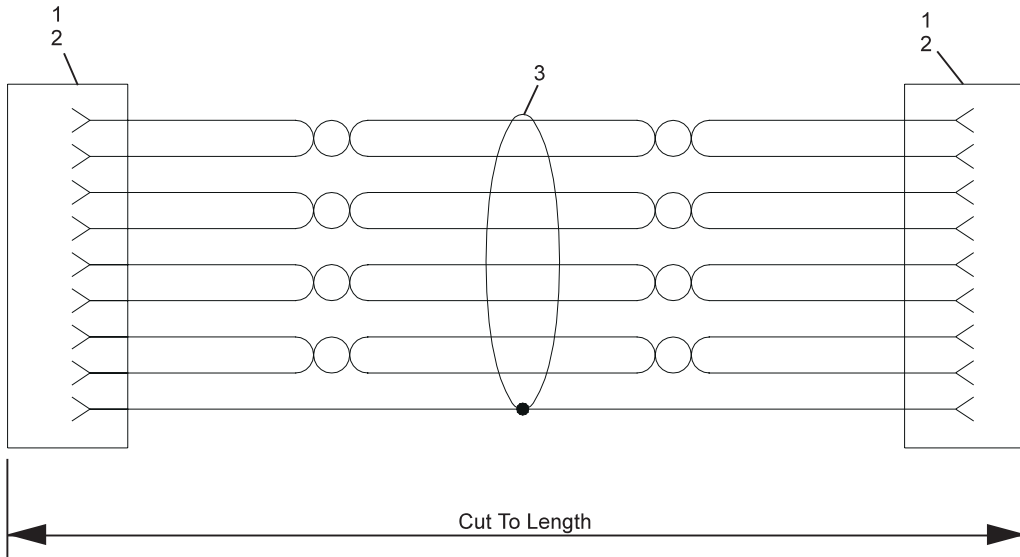

Index

No.	Part No.	Description
1.	11-697217-000	Connector
2.	11-680323-000	Terminal
3.	*27-609857-000	Bulk Stranded & Tinned Cable

** Not available as an assembly.*

**Global Video Lane Pair to Lane Pair Cable Assembly
(Field Assembly)
57-300144-000**

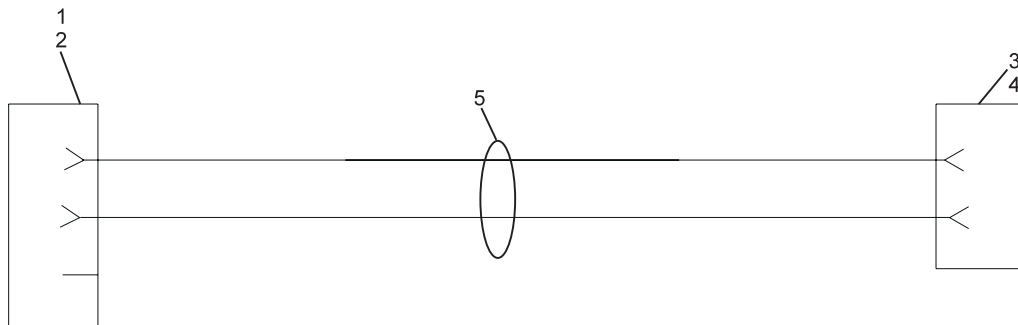

Index No.	Part No.	Description
1.	11-697237-000	Connector
2.	11-680326-000	Terminal
3.	11-691308-000	Connector
4.	11-691299-000	Terminal
5.	57-300145-000	I/O to Mother Board Reset Cable Assembly

**I/O to Mother Board Reset Cable Assembly
57-300145-000**

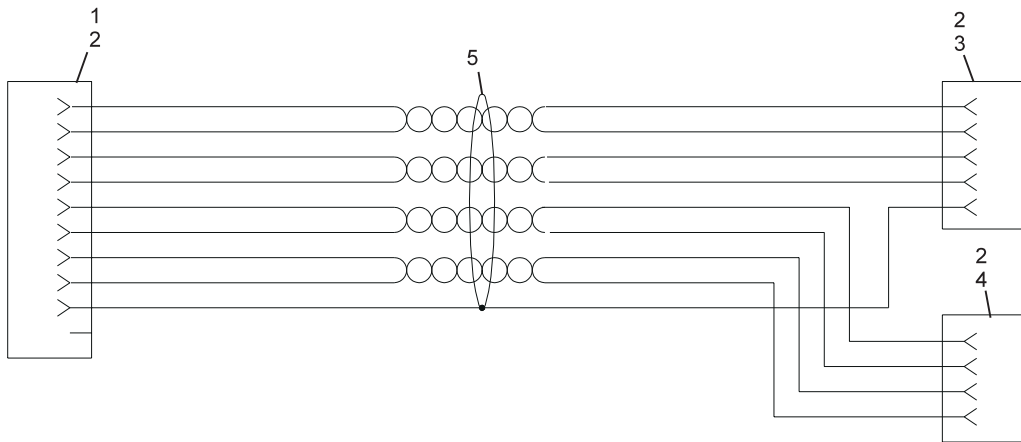

Index

No.	Part No.	Description
1.	11-697217-000	Connector
2.	11-680326-000	Terminal
3.	11-697216-000	Connector
4.	11-697238-000	Connector
5.	57-860980-000	Pinsetter Interface to CCD Scanner Cable Assembly

**Pinsetter Interface to CCD Scanner Cable Assembly
57-300147-000 (57-860980-000)**

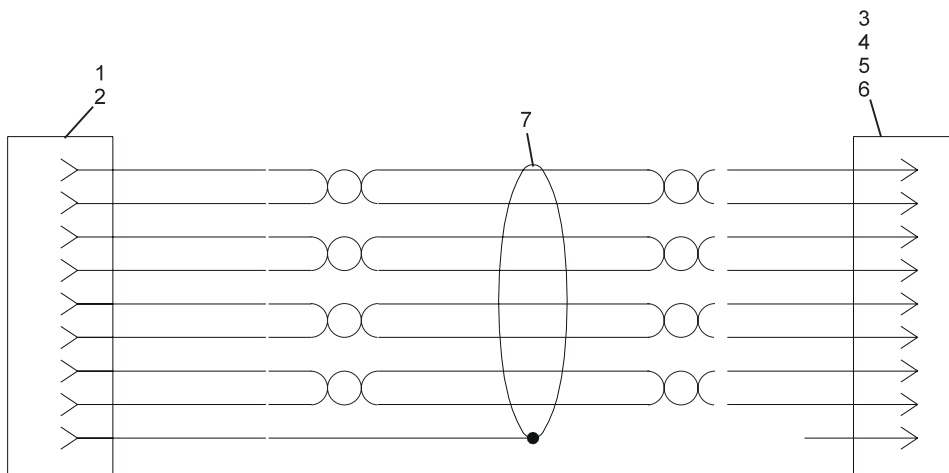

Index

No.	Part No.	Description
1.	11-697217-000	Connector
2.	11-680326-000	Terminal
3.	11-680985-000	Connector
4.	11-680981-000	Terminal
5.	11-680980-000	Clamp
6.	11-680988-000	Retainer
7.	57-300148-000	Pinsetter Interface to GS-92 Cable Assembly

**Pinsetter Interface to GS-92 Cable Assembly
57-300148-000**

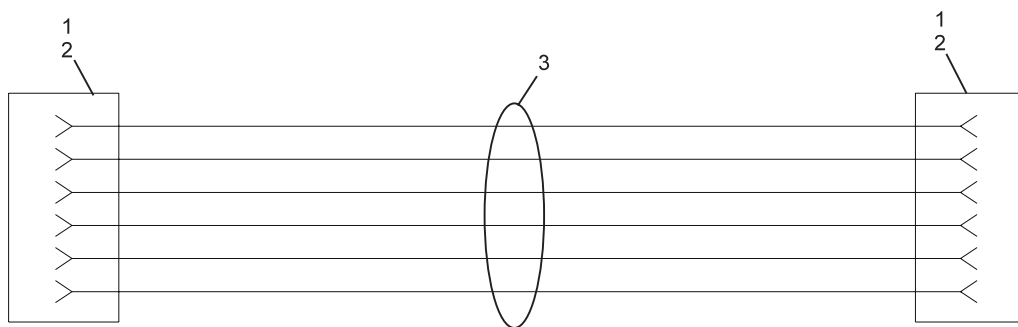

Index

No.	Part No.	Description
1.	11-697205-000	Connector
2.	11-680322-000	Terminal
3.	57-300149-000	Pinsetter Interface to GS Adapter Power Cable Assembly

**Pinsetter Interface to GS Adapter Power Cable Assembly
57-300149-000**

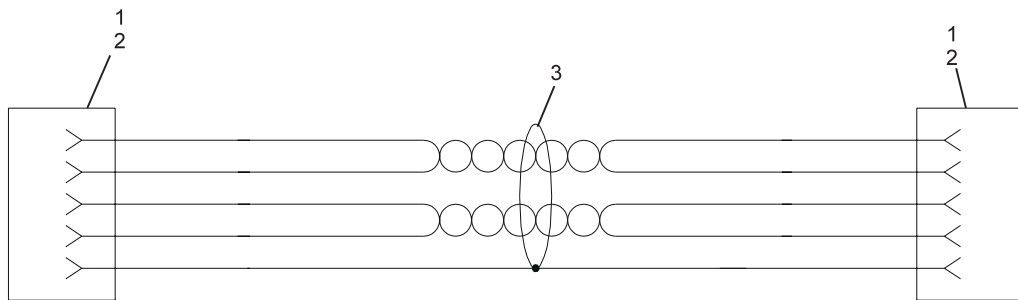

Index		
No.	Part No.	Description
1.	11-697216-000	Connector
2.	11-680326-000	Terminal
3.	57-861242-000	Curtain Wall LGP to Pinsetter Interface Local LAN Cable Assembly

**Curtain Wall LGP to Pinsetter Interface Local LAN Cable Assembly
57-300151-000 (57-861242-000)**

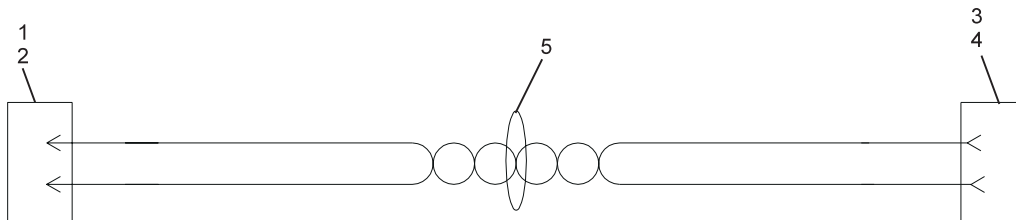

Index

No.	Part No.	Description
1.	11-680116-000	Connector
2.	11-680302-000	Terminal
3.	11-697204-000	Connector
4.	11-680322-000	Terminal
5.	57-861243-000	Curtain Wall LGP to Pinsetter Interface Power Cable Assembly

**Curtain Wall LGP to Pinsetter Interface Power Cable Assembly
57-300152-000 (57-861243-000)**

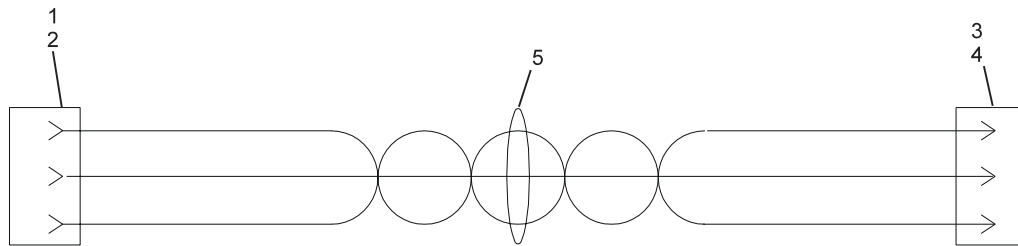

Index		
No.	Part No.	Description
1.	11-697201-000	Connector
2.	11-680322-000	Terminal
3.	11-680101-000	Connector
4.	11-680302-000	Terminal
5.	57-861235-000	LGP to Bowler Entry Station Power Cable Assembly (135')

**LGP to Bowler Entry Station Power Cable Assembly
57-300153-000 (57-861235-000)**

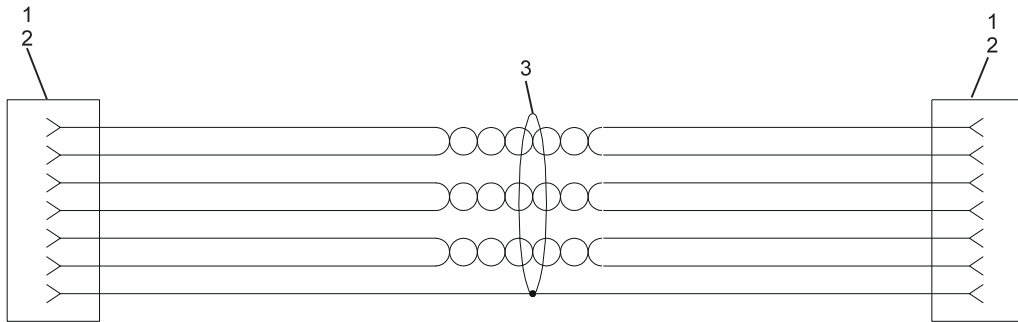

Index

No.	Part No.	Description
1.	11-697611-000	Connector
2.	11-680326-000	Terminal
3.	57-861236-000	LGP to Bowler Entry Station Local LAN Cable Assembly

**LGP to Bowler Entry Station Local LAN Cable Assembly
57-300154-000 (57-861236-000)**

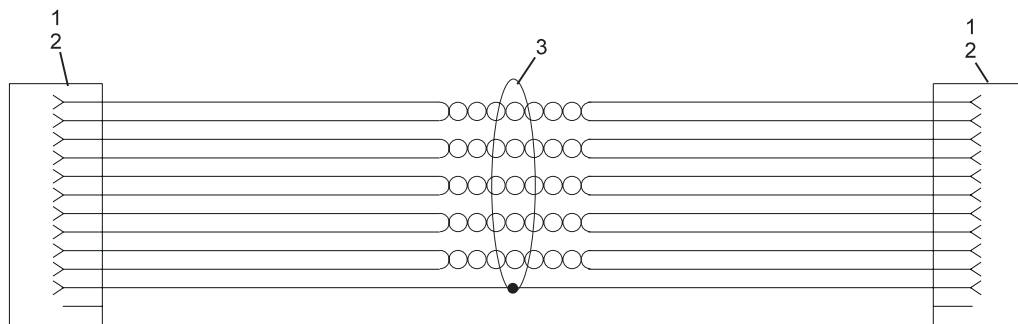

Index

No.	Part No.	Description
1.	11-697242-000	Connector
2.	11-680323-000	Terminal
3.	57-861204-000	Global Audio Primary to Secondary Console Cable Assembly (40')

NOTE: For 15' length order part number 57-861146-000.

**Global Audio Primary to Secondary Console Cable Assembly
57-300155-000 (57-861204-000)**

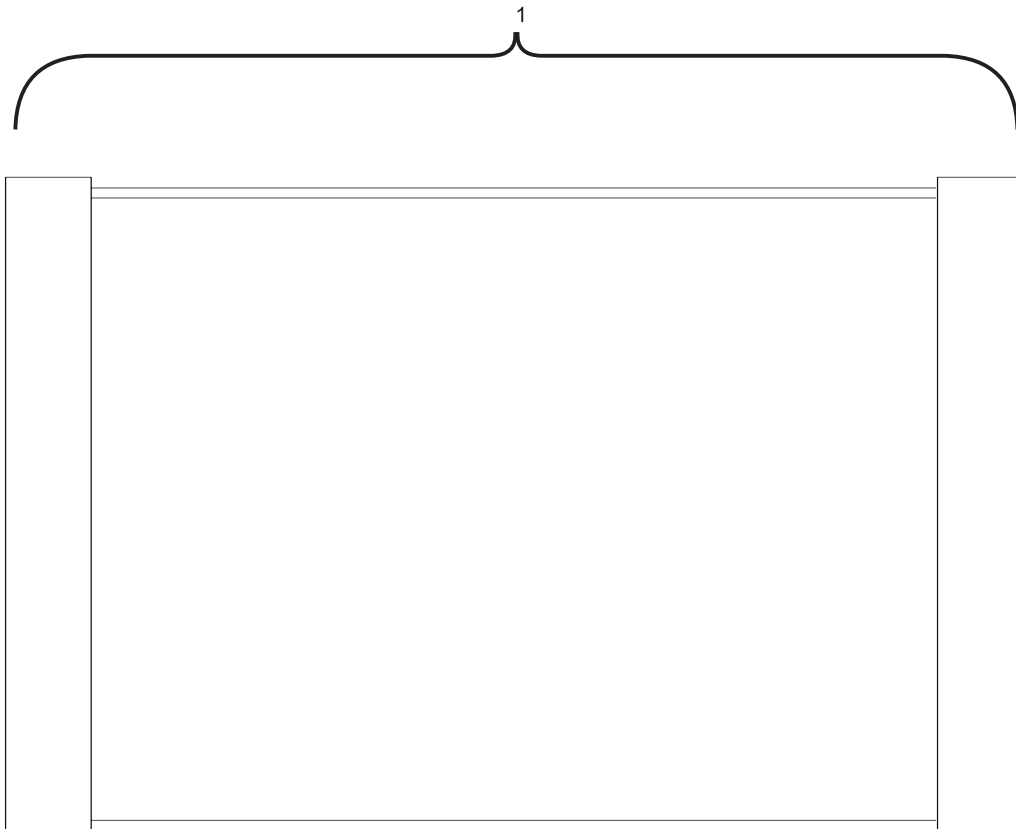

Index No.	Part No.	Description
1.	57-300156-000	I/O to Hard Drive Ribbon Cable Assembly

**I/O to Hard Drive Ribbon Cable Assembly
57-300156-000**

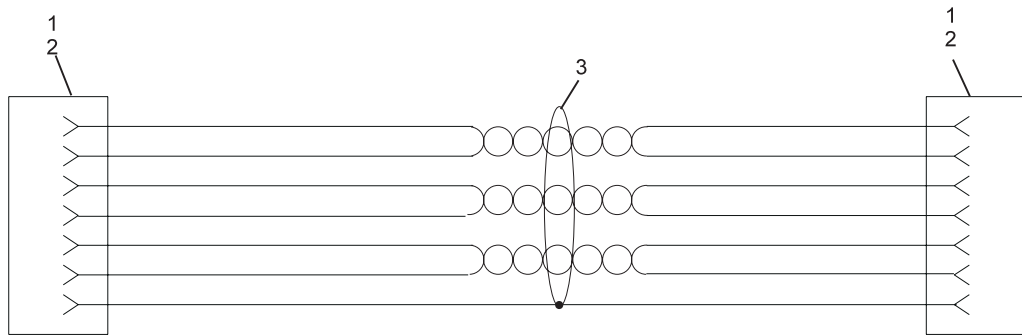

Index No.	Part No.	Description
1.	11-697611-000	Connector
2.	11-680326-000	Terminal
3.	57-300158-000	Console Controller to I/O Local LAN Cable Assembly

**Console Controller to I/O Local LAN Cable Assembly
57-300158-000**

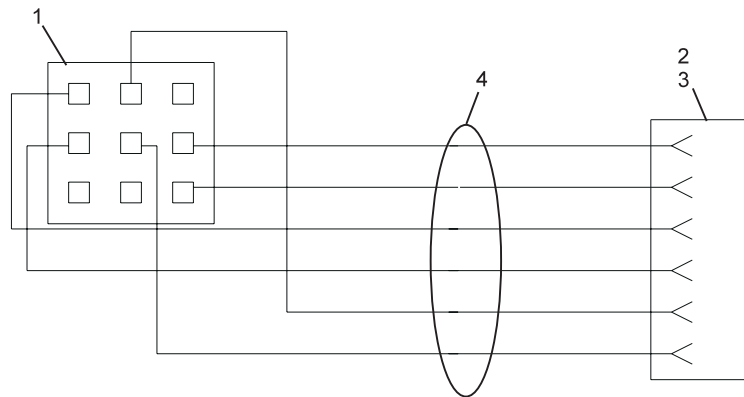

Index

No.	Part No.	Description
1.	11-615038-000	Switch
2.	11-697205-000	Connector
3.	11-680322-000	Terminal
4.	57-300289-000	Pinsetter Interface Override Switch Cable Assembly

**Pinsetter Interface Override Switch Cable Assembly
57-300289-000**

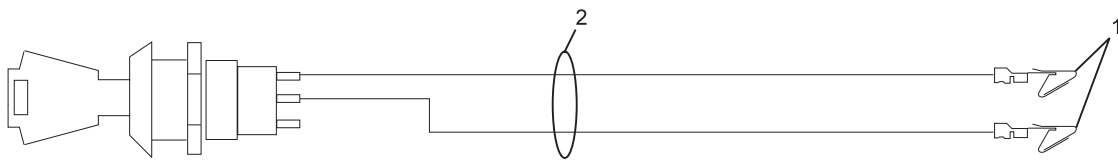

Index

No.	Part No.	Description
1.	11-680326-000	Terminal
2.	57-300290-000	Pinsetter Interface Keyswitch Cable Assembly

**Pinsetter Interface Keyswitch Cable Assembly
57-300290-000**

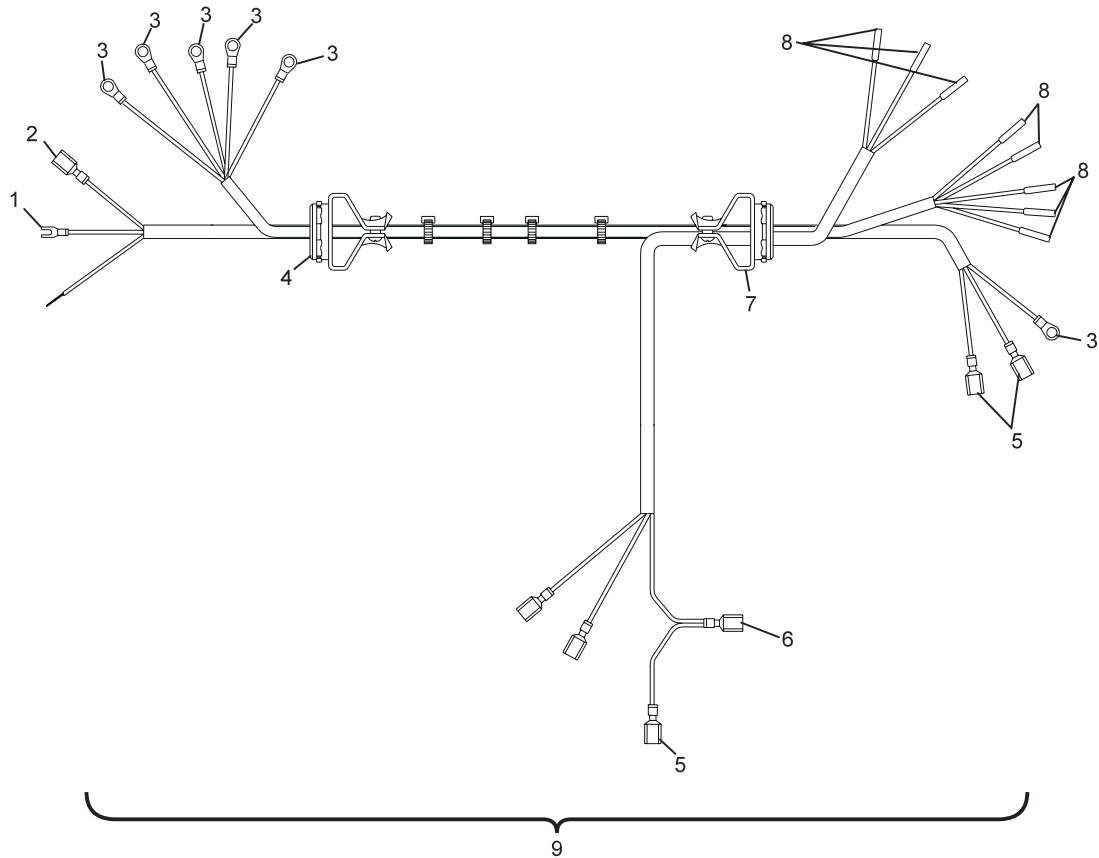

Index

No.	Part No.	Description
1.	11-612021-000	Terminal
2.	11-612152-000	Connector
3.	11-612007-000	Terminal
4.	11-602002-000	Electrical Locknut
5.	11-612151-000	Terminal
6.	11-612153-000	Terminal
7.	11-602101-000	Cord Grip
8.	11-680301-000	Pin
9.	51-300299-000	A-2 New Pins Solenoid to A-2 Electrical Box Cable Assembly

**A-2 New Pins Solenoid to A-2 Electrical Box Cable Assembly
57-300299-000**

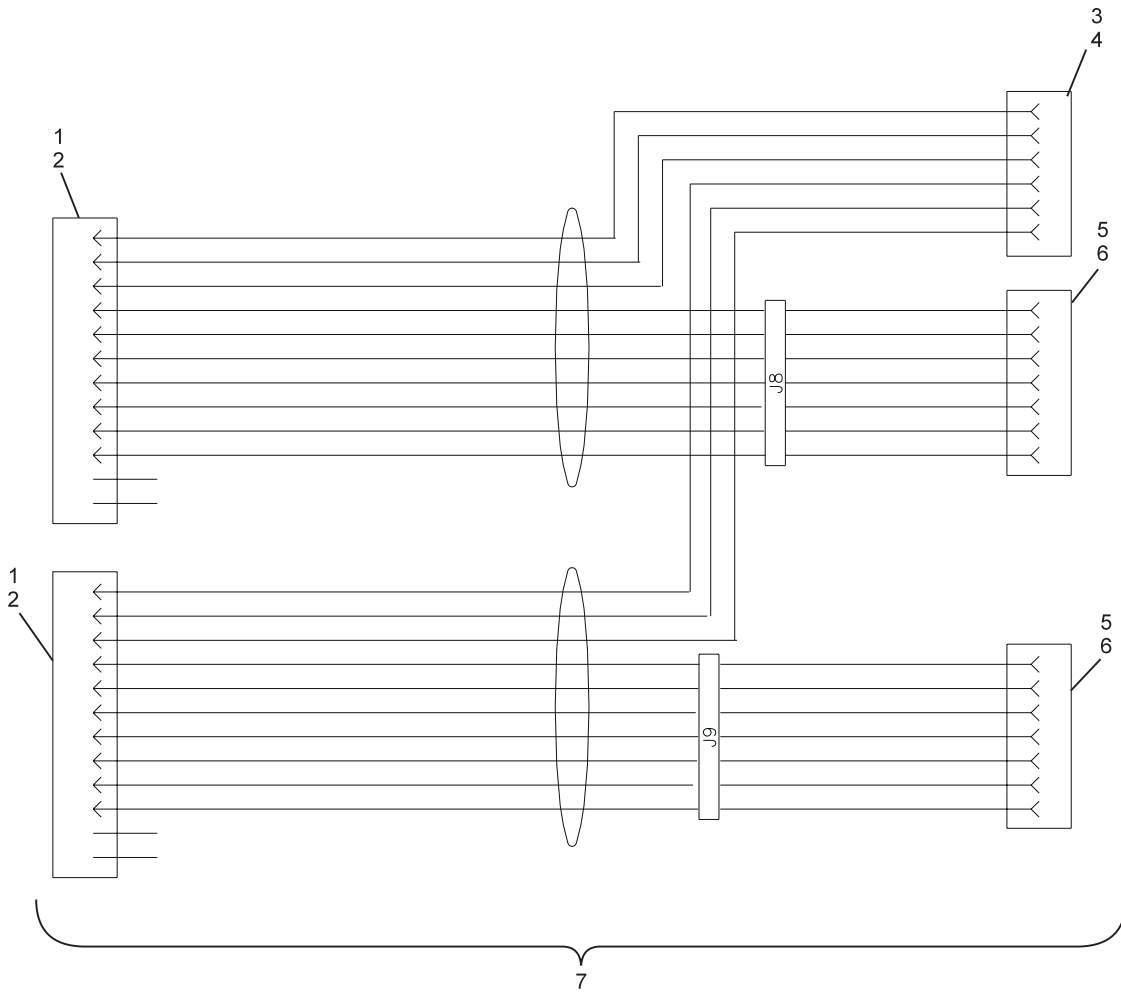

Index No.	Part No.	Description
1.	11-680108-000	Connector
2.	11-680302-000	Terminal
3.	11-680215-000	Connector
4.	11-680301-000	Terminal
5.	11-690611-000	Connector
6.	11-680326-000	Terminal
7.	57-300300-000	A-2 New Pins Solenoid to CCD Processor Cable Assembly

**A-2 New Pins Solenoid to CCD Processor Cable Assembly
57-300300-000**

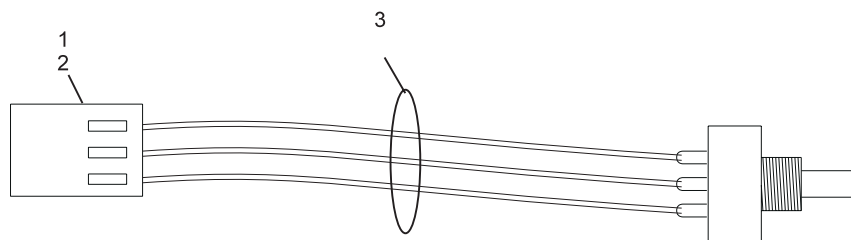

Index

No.	Part No.	Description
1.	11-697237-000	Connector
2.	11-680326-000	Terminal
3.	57-300306-000	CMS Audio Volume Control Cable Assembly (CMS Audio/Video Enclosure)

**CMS Audio Volume Control Cable Assembly
57-300306-000**

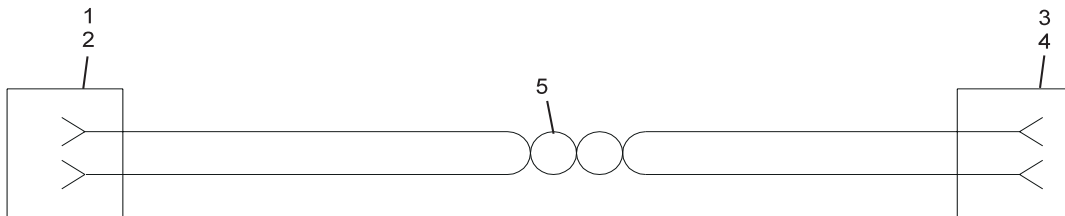

Index

No.	Part No.	Description
1.	11-697233-000	Connector
2.	11-680326-000	Terminal
3.	11-680216-000	Connector
4.	11-680301-000	Terminal
5.	57-300384-000	Bowler Entry Station to Loudspeaker Cable Assembly

**Bowler Entry Station to Loudspeaker Cable Assembly
57-300384-000**

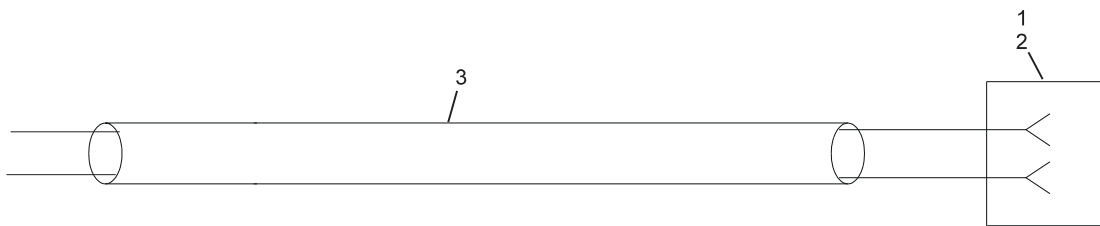

Index		
No.	Part No.	Description
1.	11-680301-000	Terminal
2.	11-680216-000	Connector
3.	57-300385-000	Speaker to Keyboard Interface PCB Cable Assembly

Speaker to Keyboard Interface PCB Cable Assembly
57-300385-000

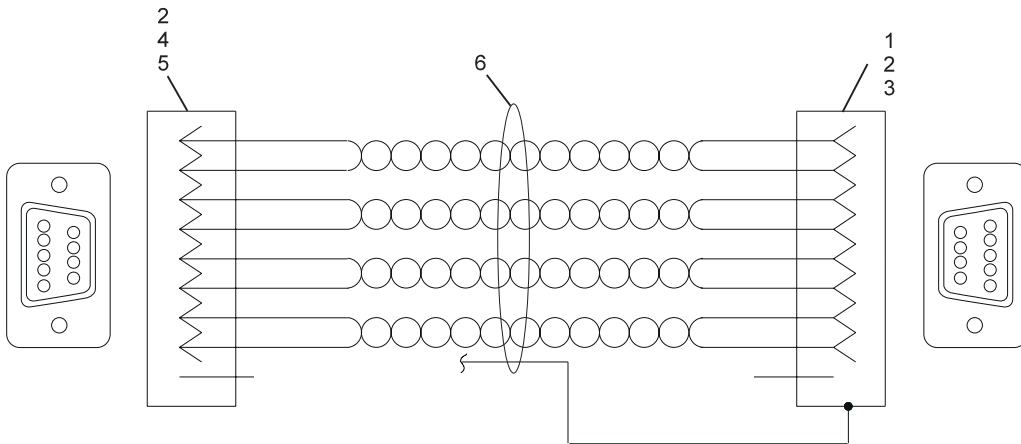

Index

No.	Part No.	Description
1.	11-680995-000	Connector
2.	11-680996-000	Cover
3.	11-680983-000	Socket
4.	11-680985-000	Plug
5.	11-680981-000	Terminal
6.	57-861179-000	BowlerTrack LAN w/Gamesetter Cable Assembly (250')

**BowlerTrack LAN w/Gamesetter Cable Assembly
57-300403-000 (57-861179-000)**

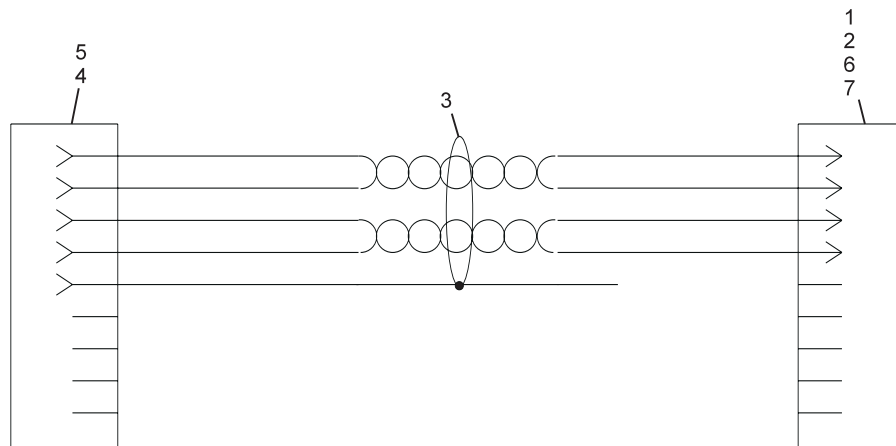

Index

No.	Part No.	Description
1.	11-680985-000	Connector
2.	11-680981-000	Terminal
3.	57-861183-000	BowlerTrack LAN w/o Gamesetter Cable Assembly (250')
4.	11-697217-000	Connector
5.	11-680326-000	Terminal
6.	11-680996-000	Cover
7.	11-680988-000	Screw

**BowlerTrack LAN w/o Gamesetter Cable Assembly
57-300404-000 (57-861183-000)**

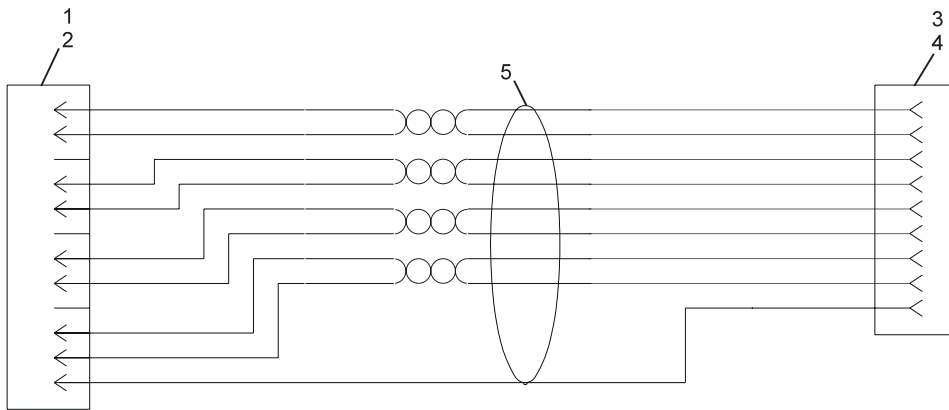

Index No.	Part No.	Description
1.	11-680108-000	Connector
2.	11-680302-000	Terminal
3.	11-691289-000	Connector
4.	11-691299-000	Terminal
5.	57-861184-000	Overhead Monitor Video Input Cable Assembly (Extra Long)

**Overhead Monitor Video Input Cable Assembly (Extra Long)
57-300405-000 (57-861184-000)**

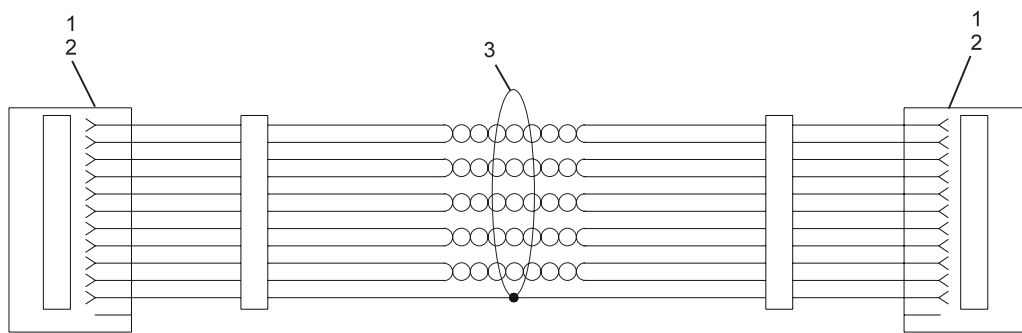

Index

No.	Part No.	Description
1.	11-697242-000	Connector
2.	11-680323-000	Terminal
3.	57-300406-000	Intercom Floor-to-Floor Cable Assembly (Field Assembled)

Intercom Floor-to-Floor Cable Assembly
(Field Assembly)
57-300406-000

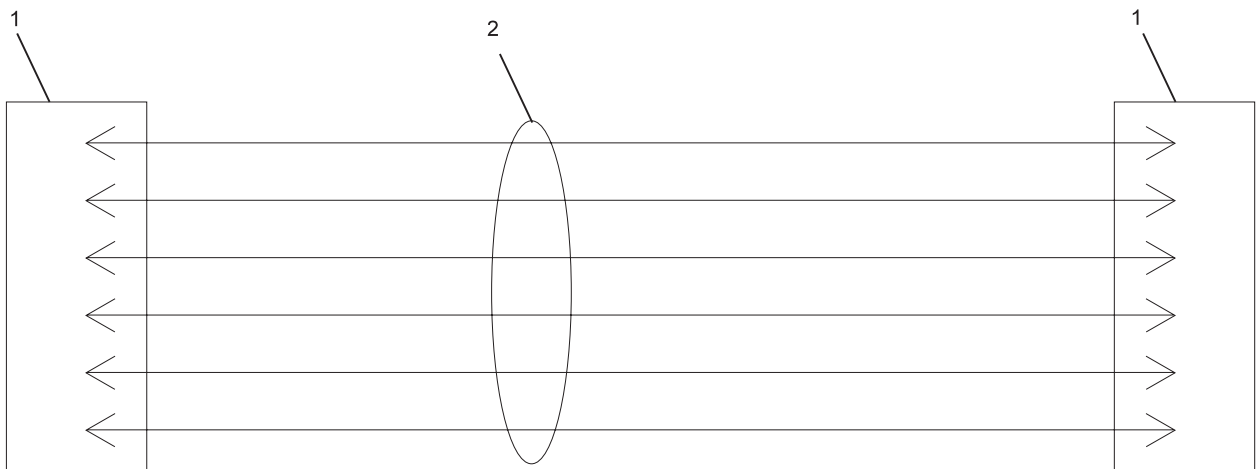

Index

No.	Part No.	Description
1.	11-680177-002	Connector
2.	57-300498-000	Beep Speaker to Intercom Cable Assembly Short (12")

**Beep Speaker to Intercom Cable Assembly Short (12")
57-300498-000**

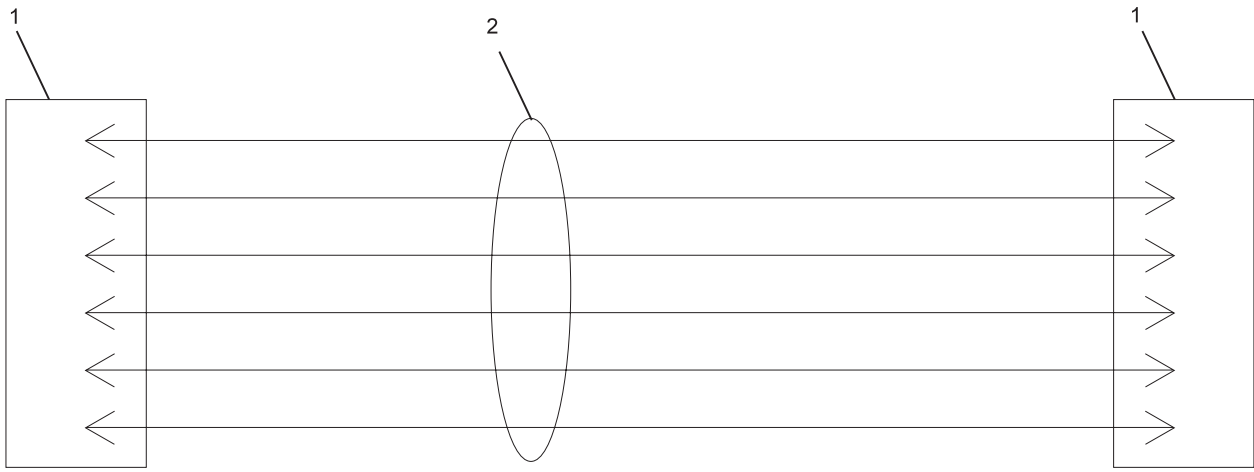

Index No.	Part No.	Description
1.	11-680177-002	Connector
2.	57-300499-000	Beep Speaker to Intercom Cable Assembly Long (15')

Beep Speaker to Intercom Cable Assembly Long (15')
57-300499-000

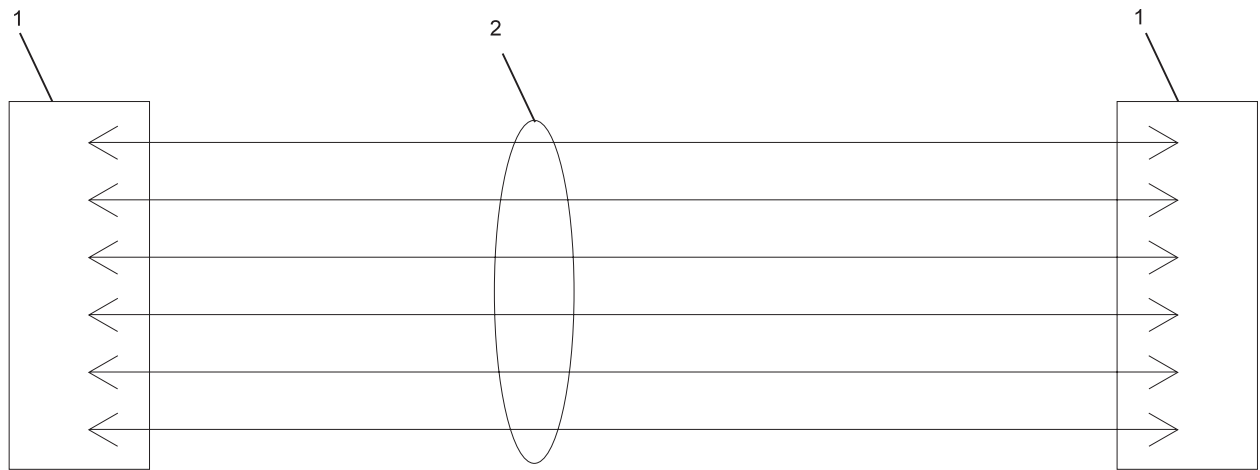

Index

No.	Part No.	Description
1.	11-680177-002	Connector
2.	57-300500-000	Beep Speaker to Front Desk A/V Cable Assembly (35')

**Beep Speaker to Front Desk A/V Cable Assembly (35')
57-300500-000**

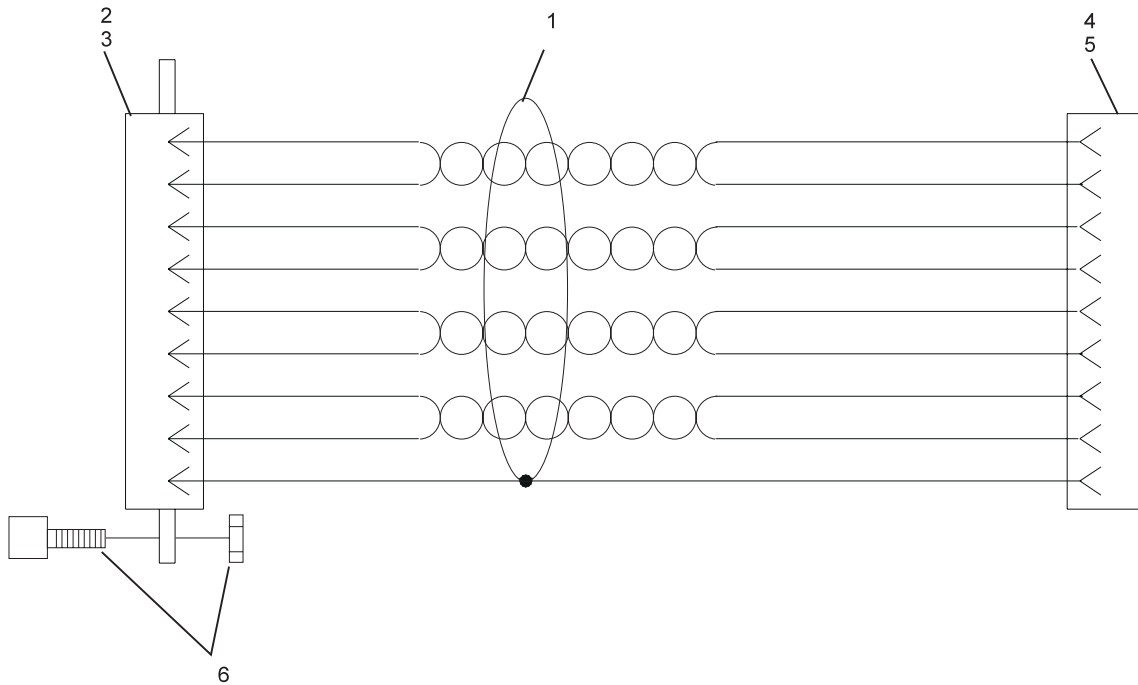

Index No.	Part No.	Description
1.	57-300537-000	Video Input Cable Assembly
2.	11-680985-000	Connector
3.	11-680981-000	Terminal
4.	11-697217-000	Connector
5.	11-680326-000	Terminal
6.	11-680989-000	Screw Lock Kit

**Video Input Cable Assembly
57-300537-000**

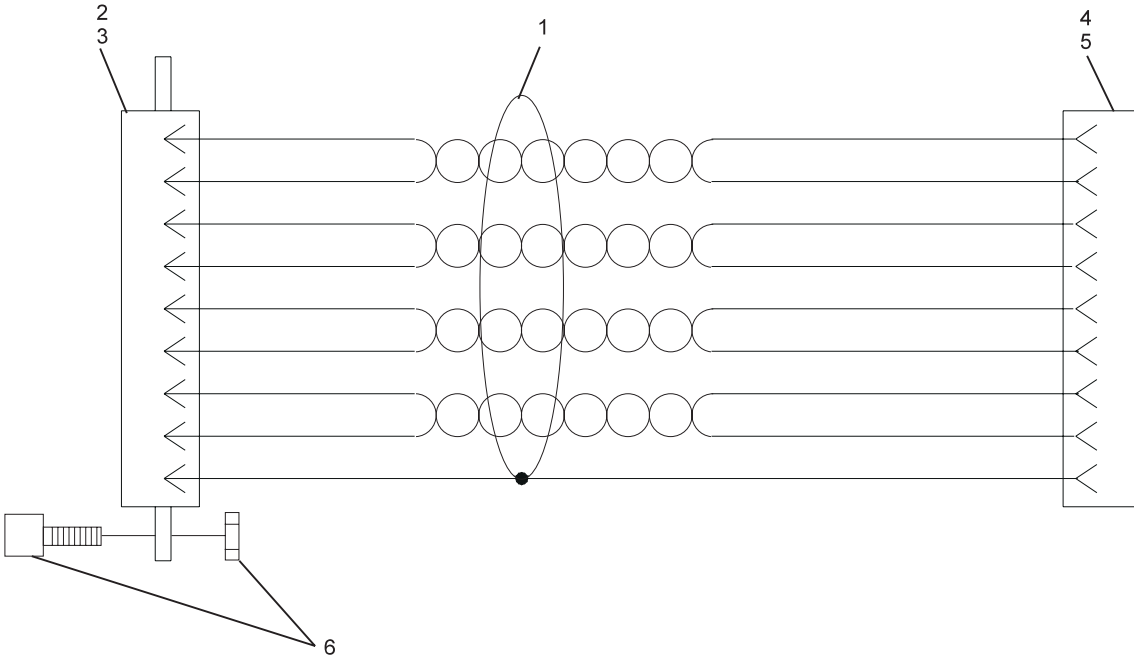

Index No.	Part No.	Description
1.	57-300538-000	Video Output Cable Assembly
2.	11-680995-000	Connector
3.	11-680983-000	Terminal
4.	11-697217-000	Connector
5.	11-680326-000	Terminal
6.	11-680989-000	Screw Lock Kit

**Video Output Cable Assembly
57-300538-000**

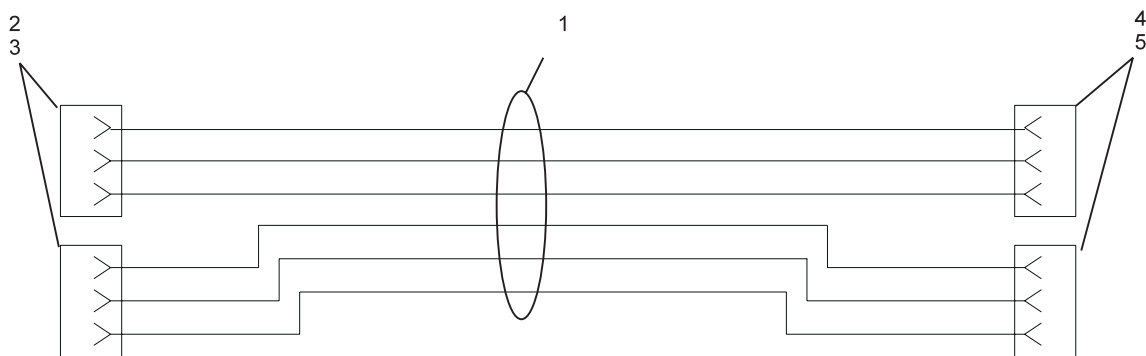

Index No.	Part No.	Description
1.	57-300543-000	Pinfall Ball Detect Cable Assembly
2.	11-697237-000	Connector
3.	11-680326-000	Terminal
4.	11-680201-000	Connector
5.	11-680301-000	Terminal

**Pinfall Ball Detect Cable Assembly
57-300543-000**

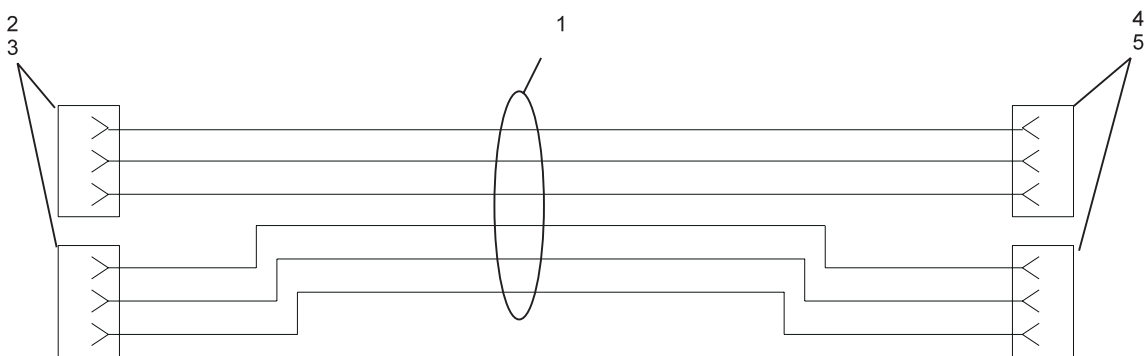

Index No.	Part No.	Description
1.	57-300544-000	Delivery Ball Detect Cable Assembly
2.	11-697237-000	Connector
3.	11-680326-000	Terminal
4.	11-680201-000	Connector
5.	11-680301-000	Terminal

**Delivery Ball Detect Cable Assembly
57-300544-000**

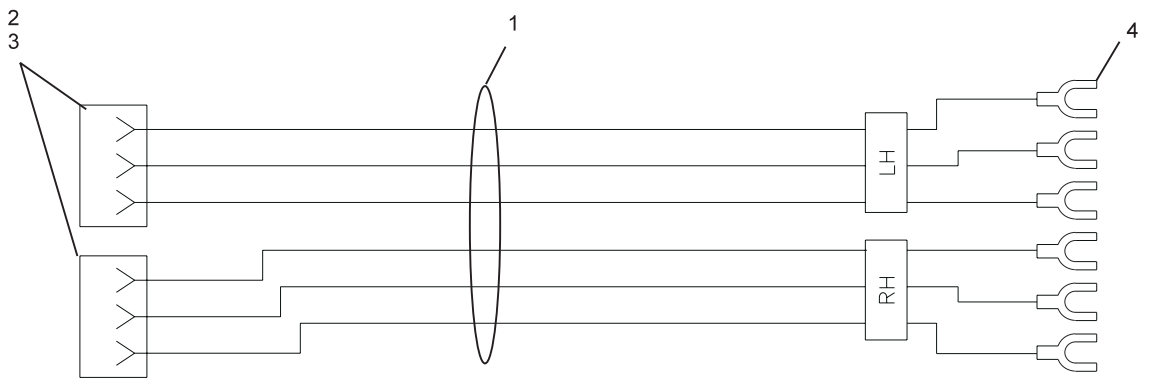

Index			
No.	Part No.	Description	
1.	57-300545-000	Approach Sensor Cable Assembly	
2.	11-697237-000	Connector	
3.	11-680326-000	Terminal	
4.	11-612022-000	Connector	

**Approach Sensor Cable Assembly
57-300545-000**

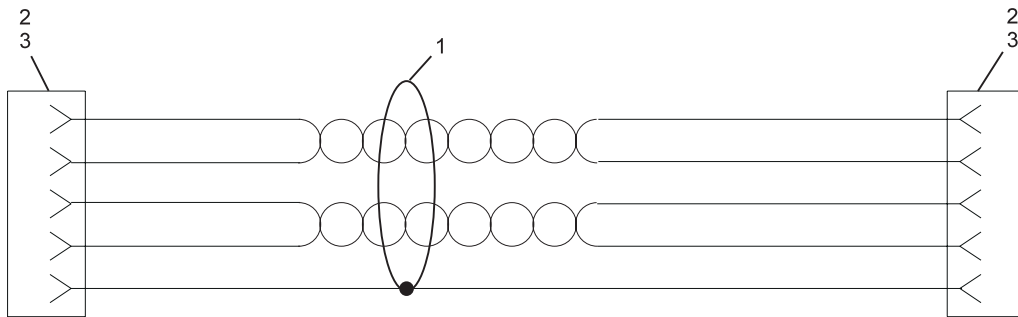

Index No.	Part No.	Description
1.	57-300546-000	Local LAN Cable Assembly
2.	11-697216-000	Connector
3.	11-680326-000	Terminal

**Local LAN Cable Assembly
57-300546-000**

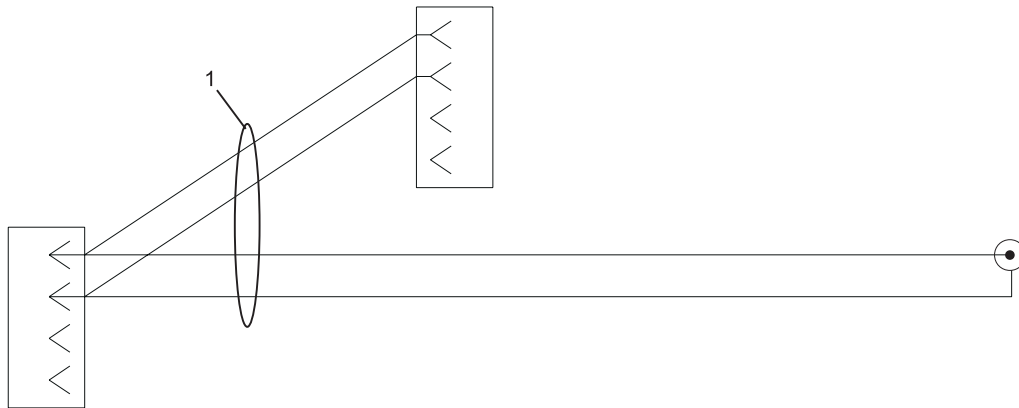

Index	No.	Part No.	Description
1.	57-300547-000	Camera Power Cable Assembly	

Camera Power Cable Assembly
57-300547-000

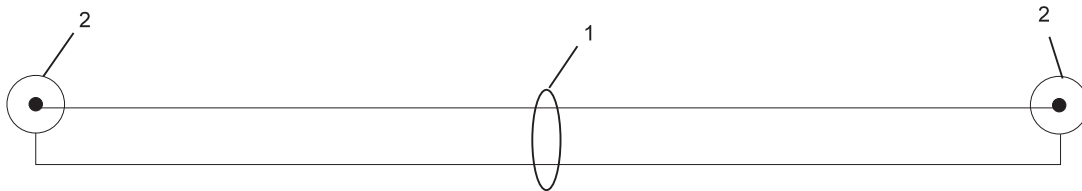

Index No.	Part No.	Description
1.	57-300548-000	Video Input to Camera Cable Assembly
2.	11-681300-000	Connector

**Video Input to Camera Cable Assembly
57-300548-000**

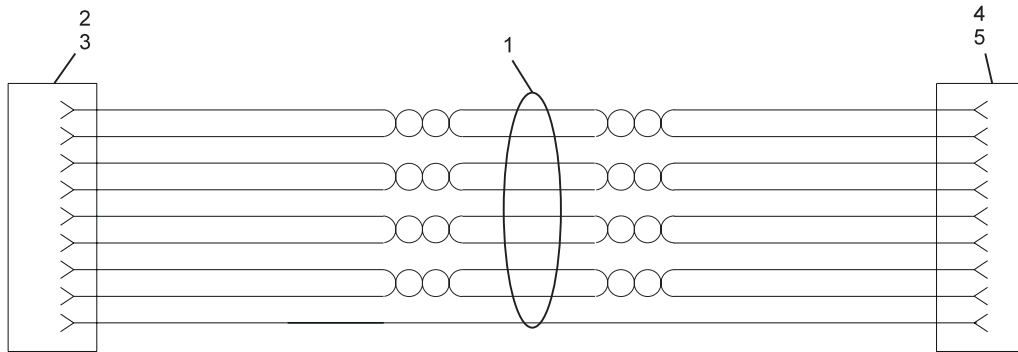

Index No.	Part No.	Description
1.	57-300562-000	Video In Instant Replay Cable Assembly
2.	11-680995-000	Connector
3.	11-680983-000	Terminal
4.	11-691289-000	Connector
5.	11-691299-000	Terminal

**Video In Instant Replay Cable Assembly
57-300562-000**

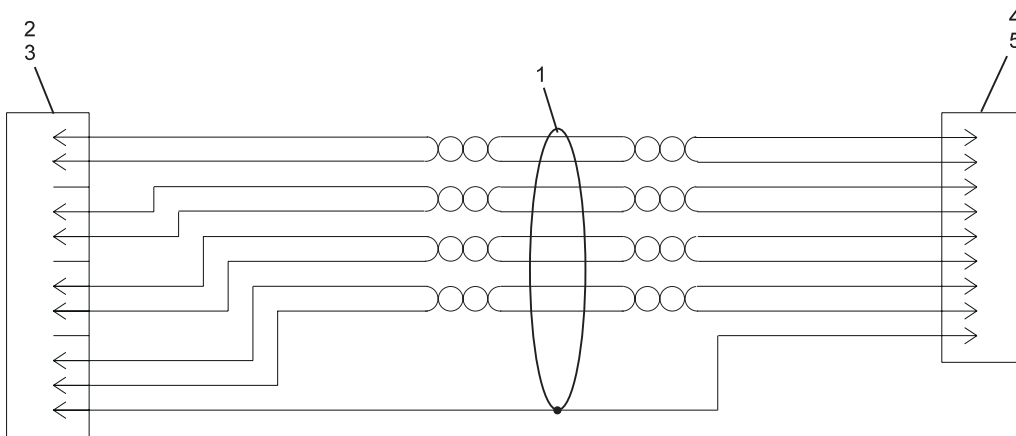

Index No.	Part No.	Description
1.	57-300563-000	Video Out Instant Replay Cable Assembly
2.	11-680108-000	Connector
3.	11-680302-000	Terminal
4.	11-680985-000	Connector
5.	11-680981-000	Terminal

**Video Out Instant Replay Cable Assembly
57-300563-000**

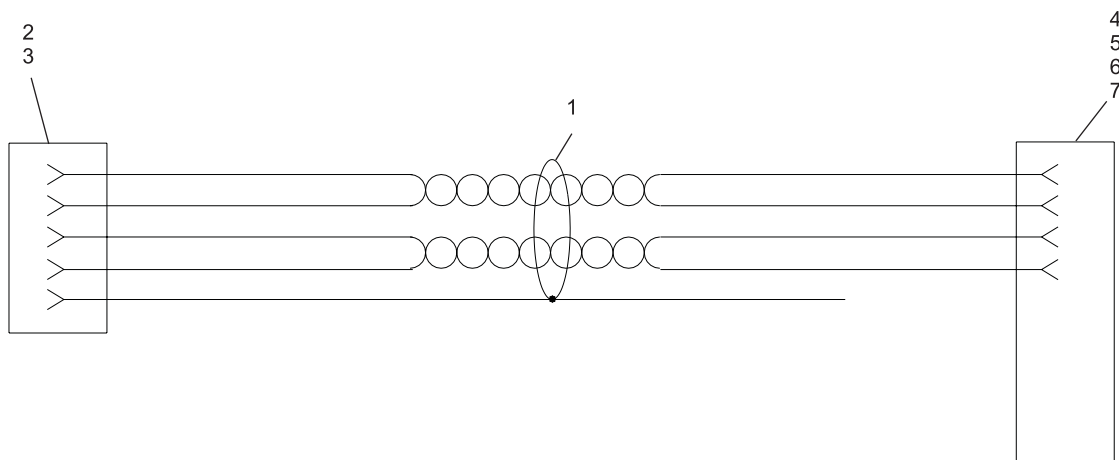

Index

No.	Part No.	Description
1.	57-300631-000	Primary Console to ConsolidatedBox - LLAN Cable Assembly
2.	11-697216-000	Connector
3.	11-680326-000	Terminal
4.	11-680995-000	Connector
5.	11-680983-000	Terminal
6.	11-680996-000	Cover
7.	57-300631-002	Screw Retainer

**Primary Console to Consolidated Box - LLAN Cable Assembly
57-300631-000 (57-861526-000)**

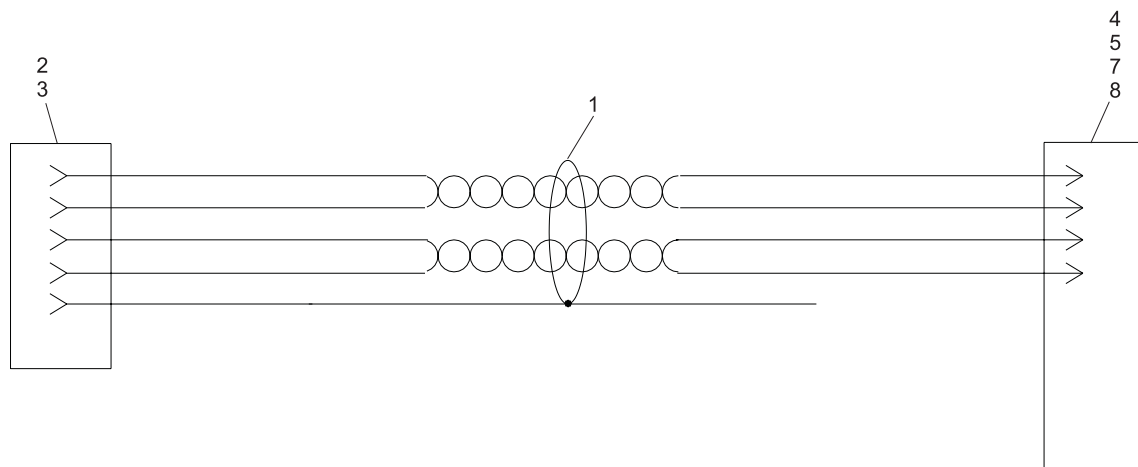

Index

No.	Part No.	Description
1.	57-300642-000	TV Only LAN IN Cable Assembly
2.	11-680107-000	Connector
3.	11-680302-000	Terminal
4.	11-680985-000	Connector
5.	11-680981-000	Terminal
6.	11-680980-000	Connector Cover
7.	11-680988-000	Retainer

**Instant Replay to TV Only LAN IN Cable Assembly
57-300642-000 (57-861513-000)**

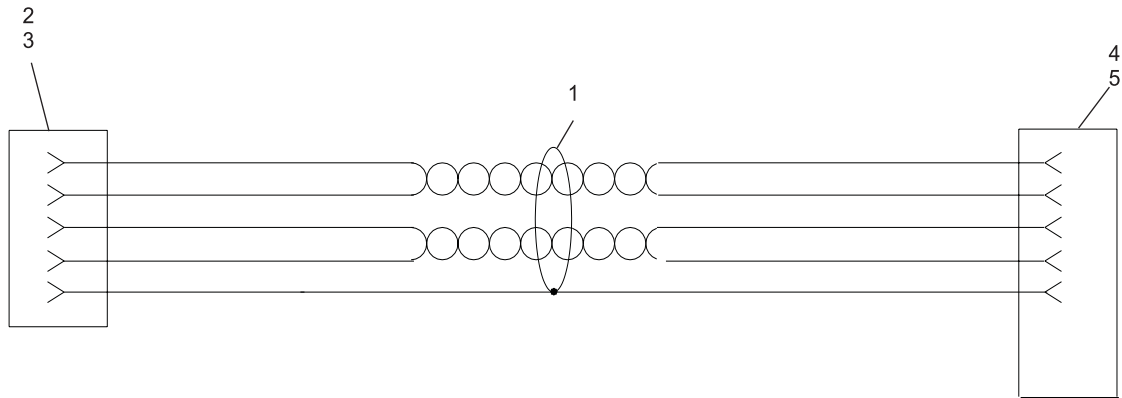

Index

No.	Part No.	Description
1.	57-300643-000	Instant replay to TV Only LLAN IN Cable Assembly
2.	11-697216-000	Connector
3.	11-680326-000	Terminal
4.	11-680107-000	Connector
5.	11-680302-000	Terminal

**Instant replay to TV Only LLAN IN Cable Assembly
57-300643-000 (57-861515-000)**

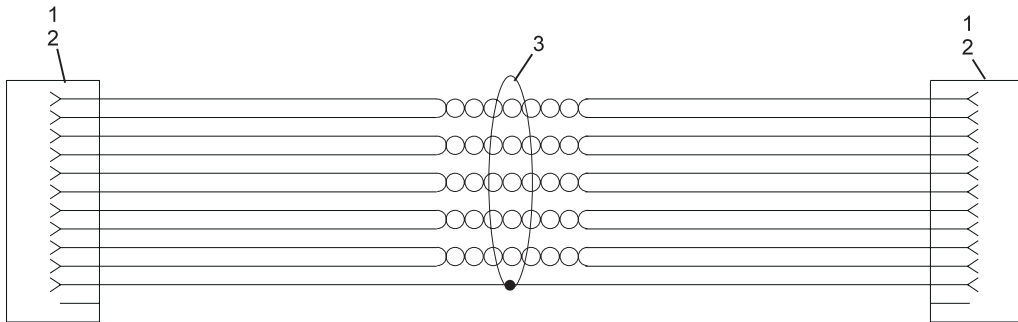

Index		
No.	Part No.	Description
1.	11-697242-000	Connector
2.	11-680323-000	Terminal
3.	57-861146-000	Global Audio Primary to Secondary Console Cable Assembly (15')

**Global Audio Primary to Secondary Console Cable Assembly
57-300680-000 (57-861146-000)**

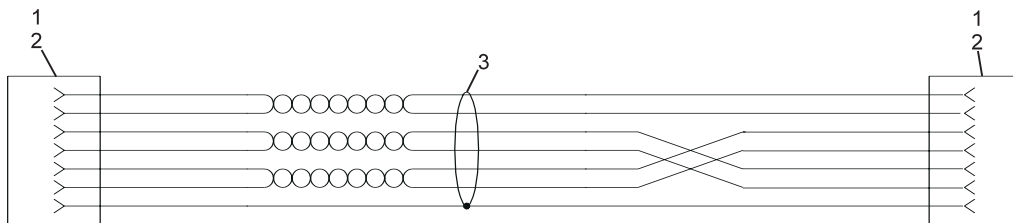

Index

No.	Part No.	Description
1.	11-697611-000	Connector
2.	11-680326-000	Terminal
3.	57-861147-000	Primary Console Local LAN to Secondary Console Local LAN Cable Assembly (15' Length)

**Primary Console Local LAN to Secondary Console Local LAN Cable Assembly
57-300681-000 (57-861147-000)**

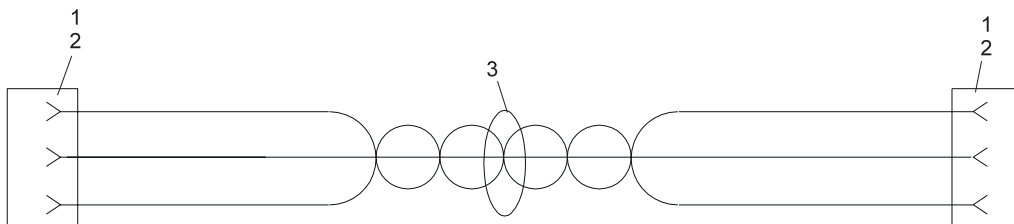

Index		
No.	Part No.	Description
1.	11-697201-000	Connector
2.	11-680322-000	Terminal
3.	57-861148-000	Primary Console 18 VAC to Secondary Console Cable Assembly (15')

**Primary Console 18 VAC to Secondary Console Cable Assembly
57-300682-000 (57-861148-000)**

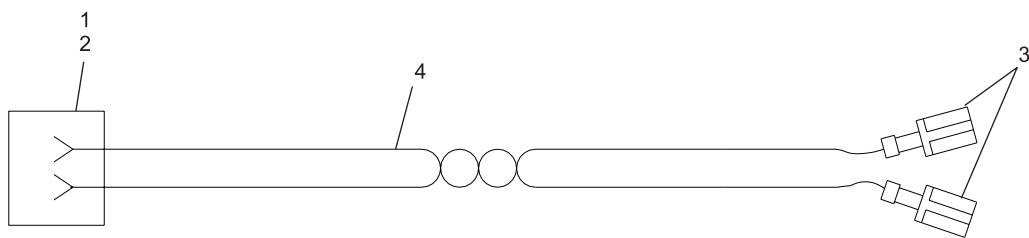

Index

No.	Part No.	Description
1.	11-697233-000	Connector
2.	11-680326-000	Terminal
3.	11-612156-000	Connector
4.	57-300734-000	Mini Console Controller to Speaker Cable Assembly

**Mini Console Controller to Speaker Cable Assembly
57-300734-000**

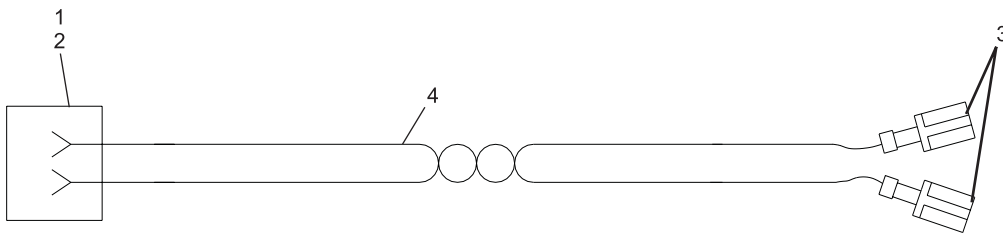

Index

No.	Part No.	Description
1.	11-697233-000	Connector
2.	11-680326-000	Terminal
3.	11-612156-000	Connector
4.	57-300735-000	Console Controller to Speaker Cable Assembly

**Console Controller to Speaker Cable Assembly
57-300735-000**

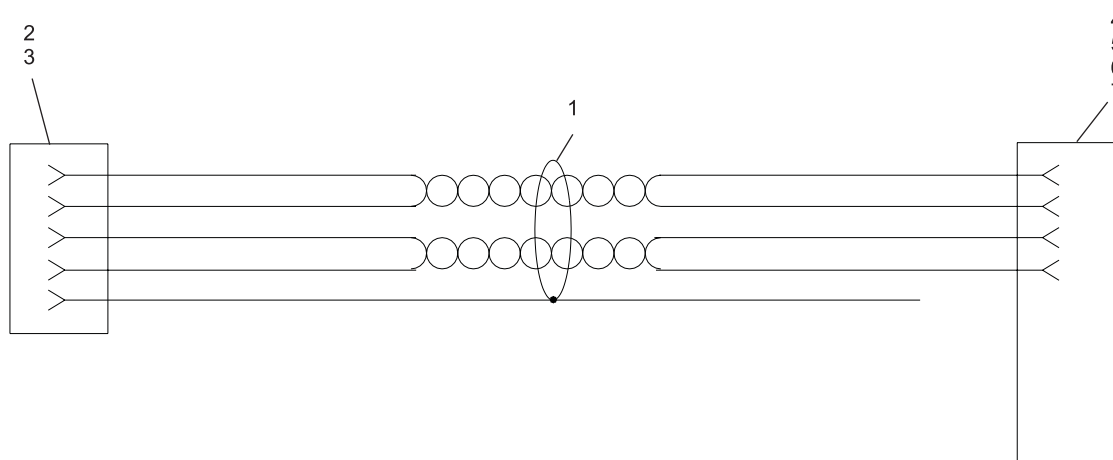

Index

No.	Part No.	Description
1.	57-300760-000	LGP to Consolidated Box Cable Assembly
2.	11-697216-000	Connector
3.	11-680326-000	Terminal
4.	11-680995-000	Connector
5.	11-680983-000	Terminal
6.	11-680996-000	Cover
7.	511-680988-000	Screw Retainer

**LGP to Consolidated Box Cable Assembly
57-300760-000 (57-861525-000)**

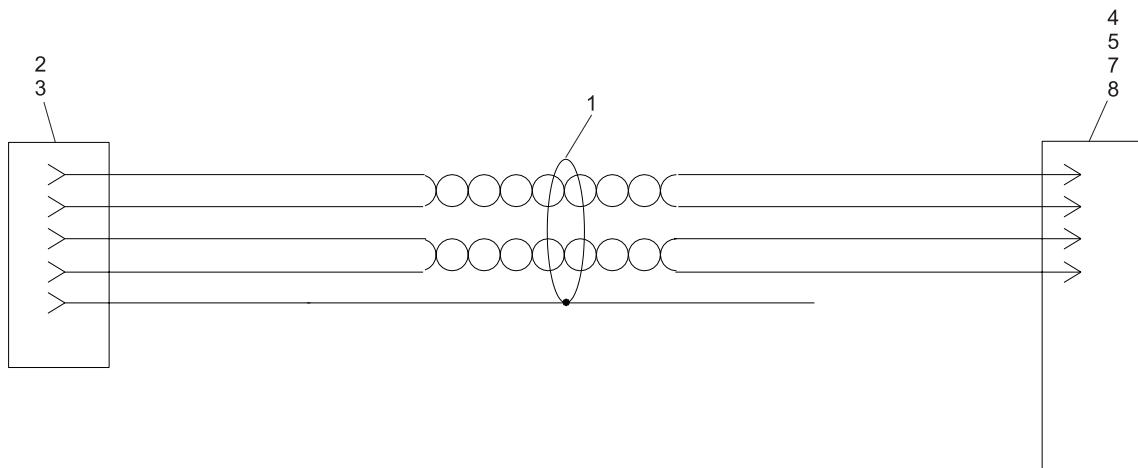

Index

No.	Part No.	Description
1.	57-300767-000	TV Only LLAN IN to Consolidated Box Comline Out Cable Assembly (245')
2.	11-697216-000	Connector
3.	11-680326-000	Terminal
4.	11-680995-000	Connector
5.	11-680983-000	Terminal
6.	11-680996-000	Cover
7.	11-680988-000	Retainer

**TV Only LLAN IN to Consolidated Box Comline Out Cable Assembly (245')
57-300767-000 (57-861514-000)**

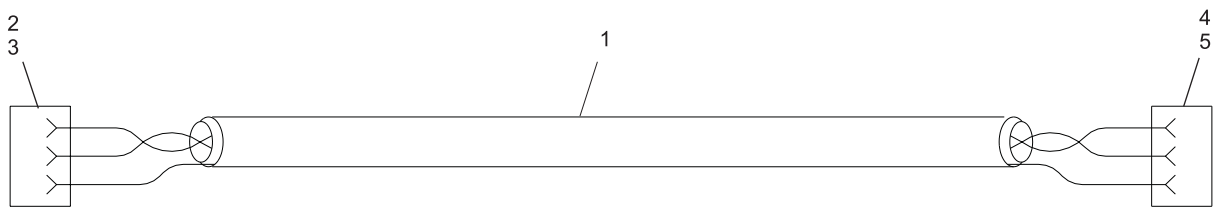

Index

No.	Part No.	Description
1.	57-300903-000	Microphone to Console Controller Cable Assembly
2.	11-680201-000	Connector
3.	11-680301-000	Terminal
4.	11-697237-000	Connector
5.	11-680326-000	Terminal

**Microphone to Console Controller Cable Assembly
57-300903-000**

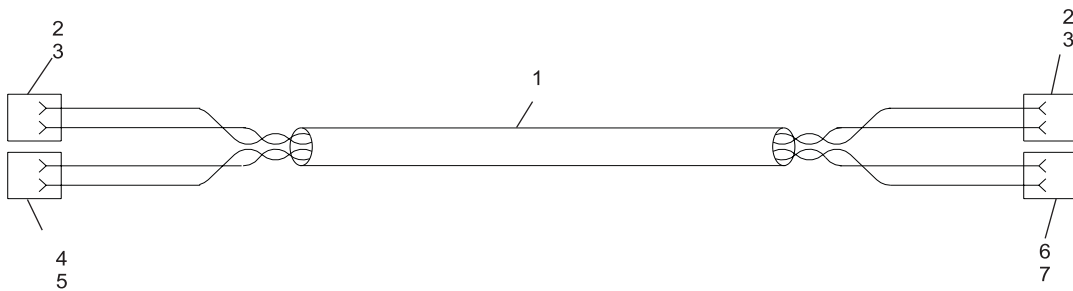

Index

No.	Part No.	Description
1.	57-300904-000	Speaker Power to Monitor Cable Assembly
2.	11-697204-000	Connector
3.	11-680322-000	Terminal
4.	11-680216-000	Connector
5.	11-680301-000	Terminal
6.	11-697233-000	Connector
7.	11-680326-000	Connector

**Speaker Power to Monitor Cable Assembly
57-300904-000**

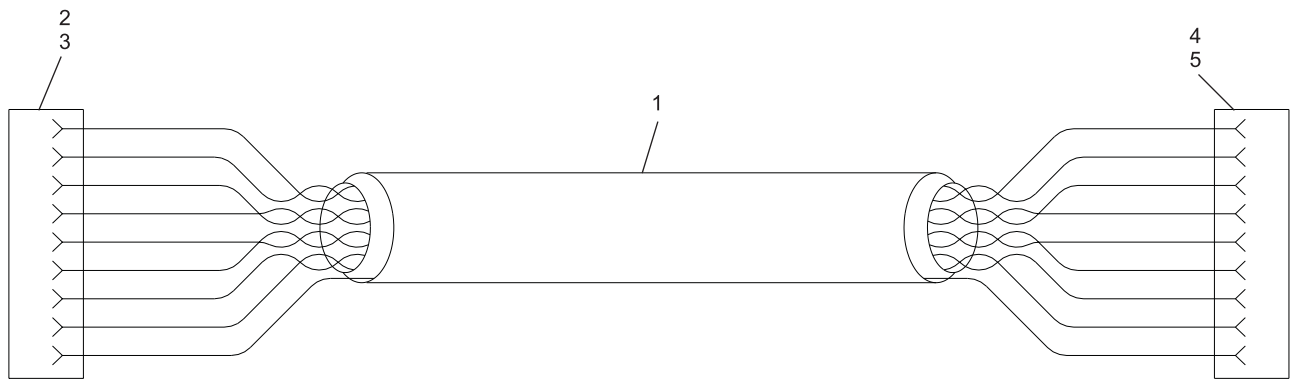

Index

No.	Part No.	Description
1.	57-300905-000	Remote Video to LCD Controller Video Cable Assembly
2.	11-697217-000	Connector
3.	11-680326-000	Terminal
4.	11-691289-000	Connector
5.	11-691299-000	Terminal

**Remote Video to LCD Controller Video Cable Assembly
57-300905-000**

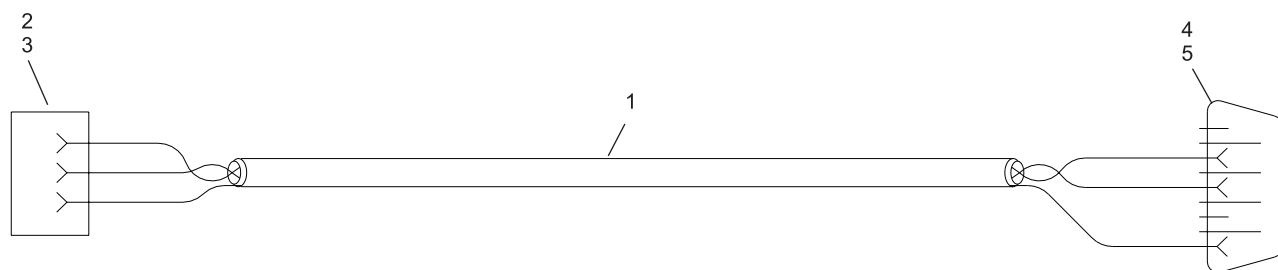

Index No.	Part No.	Description
1.	57-300909-000	LCD Controller to Option Touchscreen Cable Assembly
2.	11-697237-000	Connector
3.	11-680326-000	Terminal
4.	11-680995-000	Connector
5.	11-680983-000	Terminal

**LCD Controller to Option Touchscreen Cable Assembly
57-300909-000**

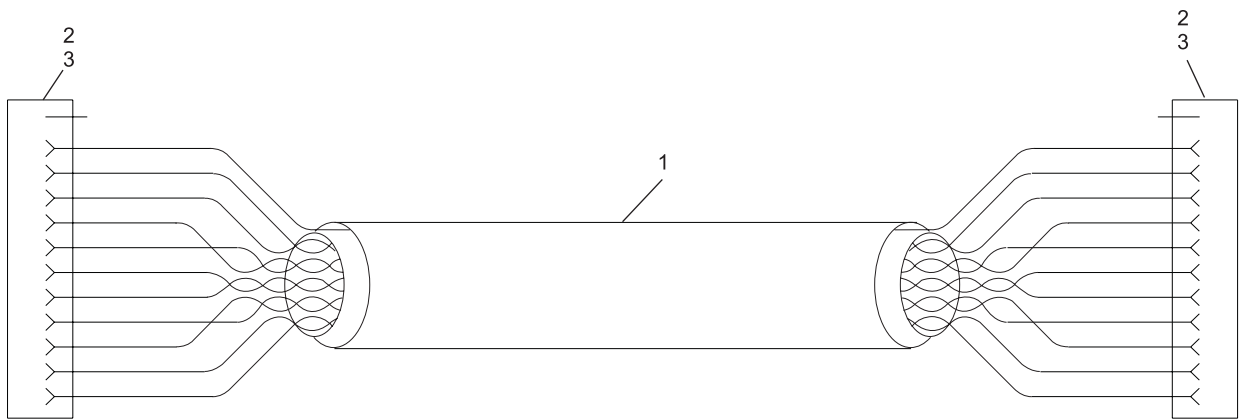

Index

No.	Part No.	Description
1.	57-300911-000	Primary to Primary Touchworx Controller- Global Audio Cable Assembly
2.	11-697242-000	Connector
3.	11-680326-000	Terminal

**Primary to Primary Touchworx Controller-Global Audio Cable Assembly
57-300911-000**

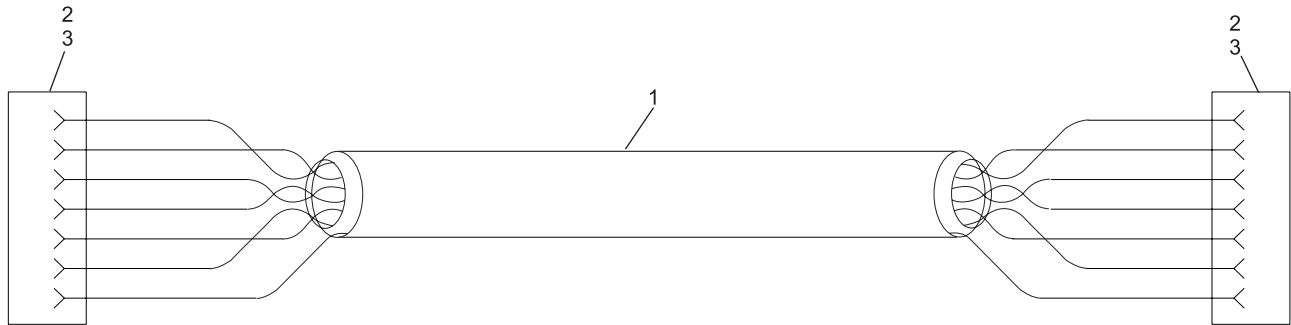

Index

No.	Part No.	Description
1.	57-300912-000	LGP to Primary Touchworx Controller LAN Cable Assembly
2.	11697611-000	Connector
3.	11-680326-000	Terminal

**LGP to Primary Touchworx Controller LAN Cable Assembly
57-300912-000**

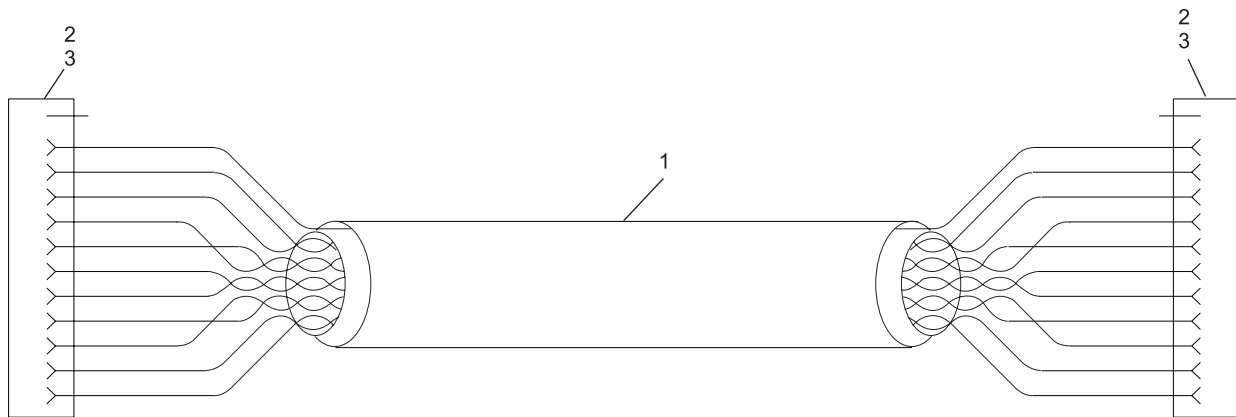

Index

No.	Part No.	Description
1.	57-300913-000	Global Audio, Teamworx Keypad Cable Assembly
2.	11697611-000	Connector
3.	11-680326-000	Terminal

**Global Audio, Teamworx Keypad Cable Assembly
57-300913-000**

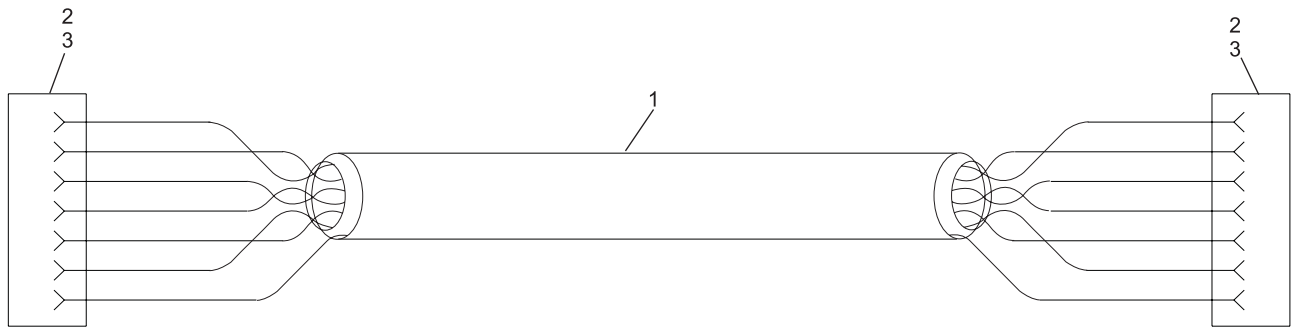

Index

No.	Part No.	Description
1.	57-300914-000	Primary to Secondary, Teamworx Keypad Local LAN Cable Assembly
2.	11-697611-000	Connector
3.	11-680326-000	Terminal

**Primary to Secondary, Teamworx Keypad Local LAN Cable Assembly
57-300914-000**

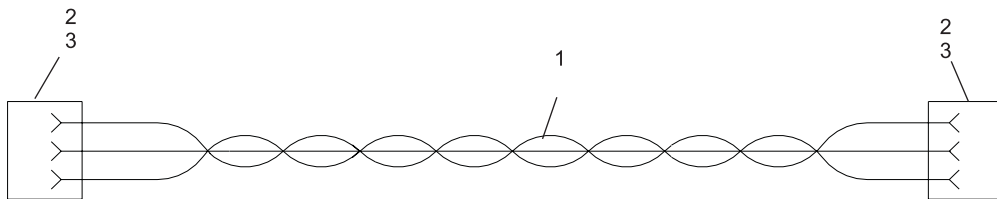

Index

No.	Part No.	Description
1.	57-300915-000	Primary to Secondary Teamworx Keypad Power Cable Assembly
2.	11-697201-000	Connector
3.	11-680322-000	Terminal

**Primary to Secondary Teamworx Keypad Power Cable Assembly
57-300915-000**

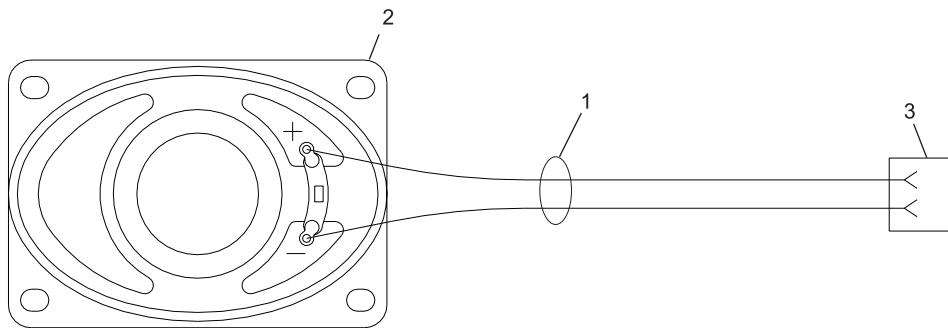

Index No.	Part No.	Description
1.	57-300916-000	Speaker Teamworx Keypad Cable Assembly
2.	11-690507-000	Speaker
3.	11-697233-000	Connector
4.	11-680326-000	Terminal

**Speaker Teamworx Keypad Cable Assembly
57-300916-000 (57-861853-400)**

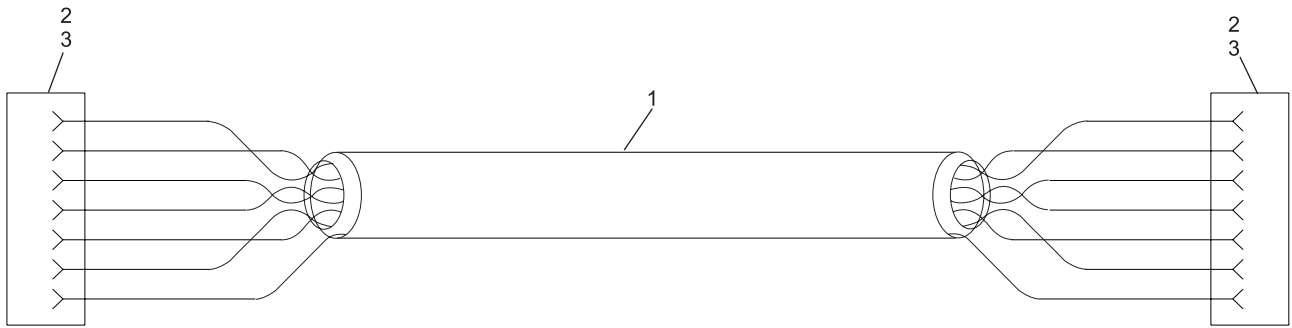

Index No.	Part No.	Description
1.	57-300935-000	Primary to Secondary Teamworx Keypad Local LAN Cable Assembly
2.	11-697611-000	Connector
3.	11-680326-000	Terminal

**Primary to Secondary Teamworx Keypad Local LAN Cable Assembly
57-300935-000**

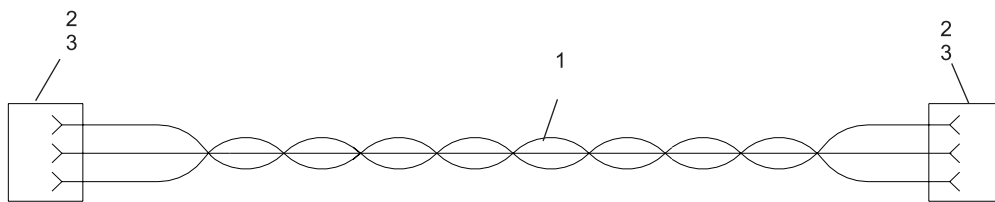

Index

No.	Part No.	Description
1.	57-300936-000	Primary to Secondary Teamworx Keypad Power Cable Assembly
2.	11-697201-000	Connector
3.	11-680322-000	Housing

**Primary to Secondary Teamworx Keypad Power Cable Assembly
57-300936-000**

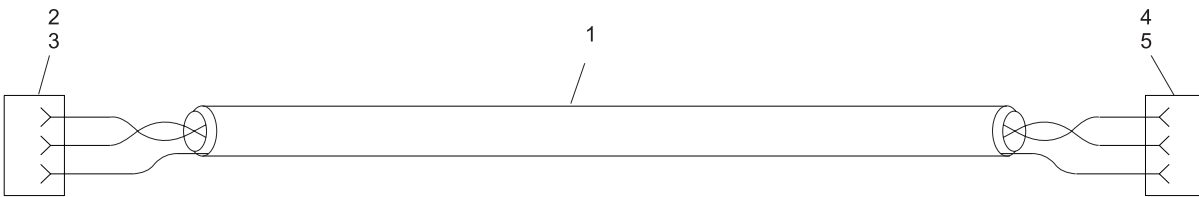

Index

No.	Part No.	Description
1.	57-300937-000	Microphone to Console Controller Cable Assembly
2.	11-680201-000	Connector
3.	11-680301-000	Terminal
4.	11-697237-000	Connector
5.	11-680326-000	Terminal

**Microphone to Console Controller Cable Assembly
57-300937-000**

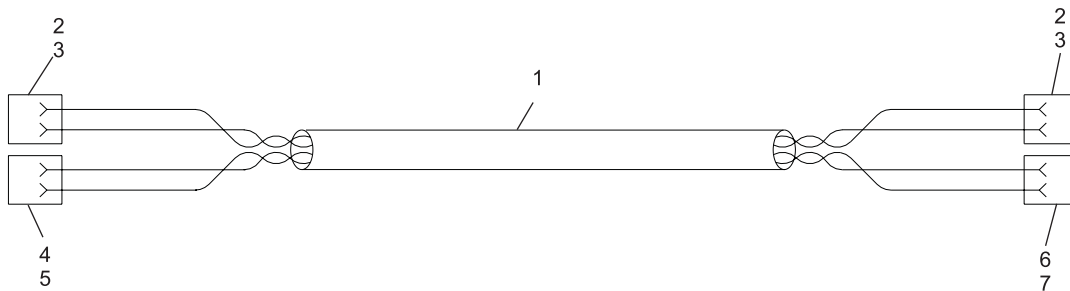

Index

No.	Part No.	Description
1.	57-300938-000	Speaker/Power Touchworx Controller Unit to LCD Cable Assembly
2.	11-697204-000	Connector
3.	11-680322-000	Terminal
4.	11-680216-000	Connector
5.	11-680301-000	Terminal
6.	11-697233-000	Connector
7.	11-680326-000	Terminal

**Speaker/Power Touchworx Control Unit to LCD Cable Assembly
57-300938-000**

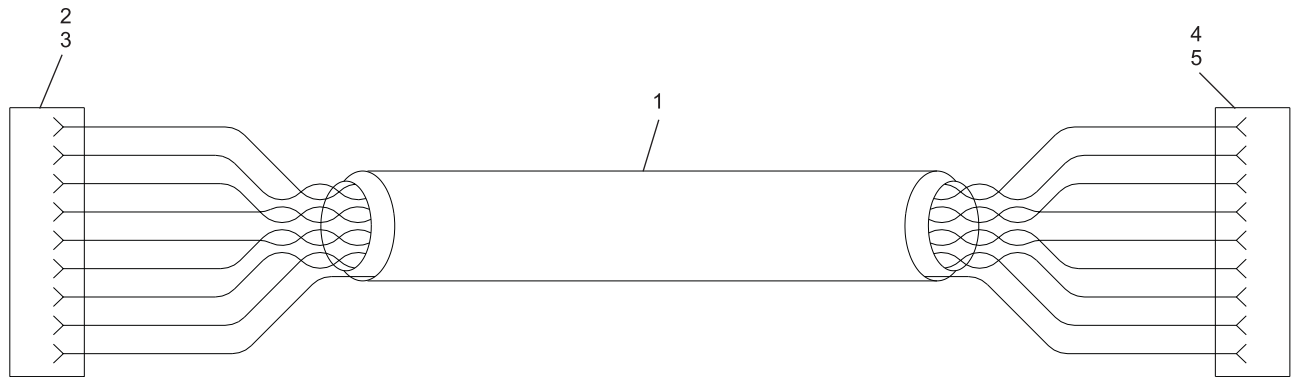

Index

No.	Part No.	Description
1.	57-300939-000	Remote Video to LCD Controller
2.	11-697217-000	Connector
3.	11-680326-000	Terminal
4.	11-691289-000	Connector
5.	11-691299-000	Terminal

**Remote Video to LCD Controller Cable Assembly
57-300939-000**

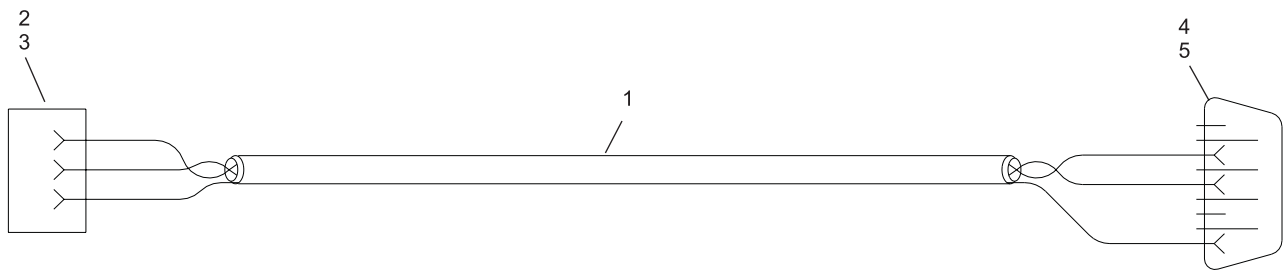

Index

No.	Part No.	Description
1.	57-300940-000	LCD Controller to Option Touchscreen Cable Assembly
2.	11-697237-000	Connector
3.	111-680326-000	Terminal
4.	11-680995-000	Connector
5.	11-680983-000	Terminal

**LCD Controller Option Touchscreen Cable Assembly
57-300940-000**

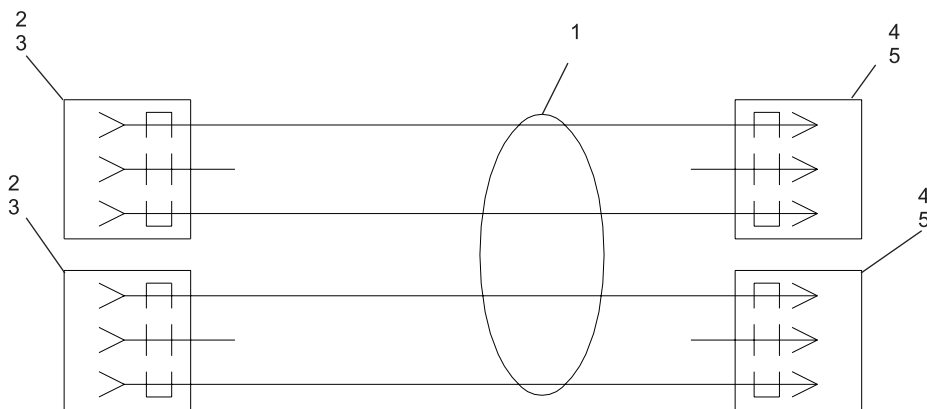

Index No.	Part No.	Description
1.	68-100659-000	Foul to Optical Trigger Cable Assembly
2.	11-680201-000	Connector
3.	11-680301-000	Terminal
4.	11-680101-000	Connector
5.	11-680302-000	Terminal

**Foul to Optical Trigger Cable Assembly
68-100659-000 (47-862717-000)**

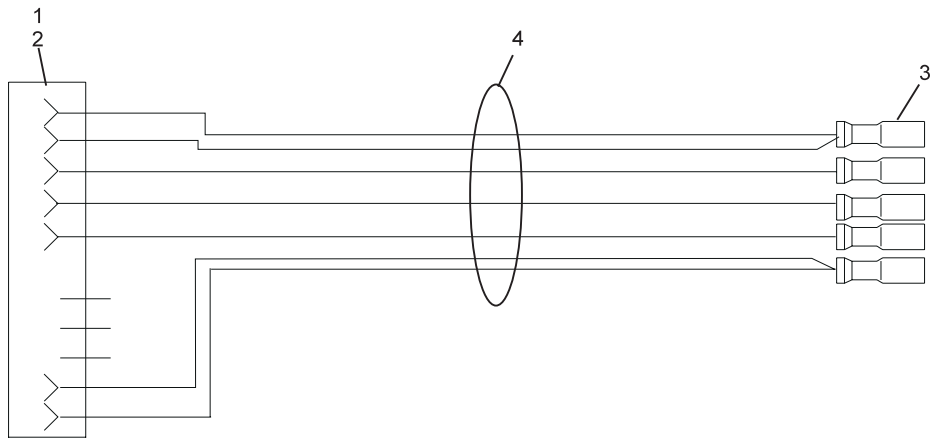

Index No.	Part No.	Description
1.	11-697214-000	Connector
2.	11-680322-000	Terminal
3.	11-612151-000	Terminal
4.	68-100827-000	Power Cable Assembly (BowlerTrack Assembly)

**BowlerTrack Power Cable Assembly
68-100827-000**

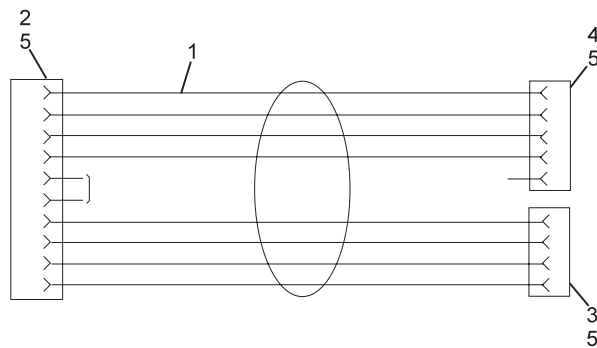

Index

No.	Part No.	Description
1.	68-300226-000	CCD Processor to BowlerVision A/P Controller Cable Assembly
2.	11-697218-000	Connector
3.	11-697238-000	Connector
4.	11-697216-000	Connector
5.	11-680326-000	Terminal

**CCD Processor to BowlerVision A/P Controller Cable Assembly
68-300226-000**